

# ATTO D4 DC 3I 230-240Vac

## INSTALLATION INSTRUCTIONS

### COPYRIGHT

Electrex is a trademark of Akse S.r.l. All rights reserved.  
It is forbidden to duplicate, adapt, transcript this document without Akse written authorization, except when regulated accordingly by the Copyright Laws.

### WARRANTY

This product is covered by a warranty against material and manufacturing defects for a period of 24 months period from the manufacturing date.  
The warranty does not cover the defects that are due to:

- Negligent and improper use
- Failures caused by atmospheric hazards
- Acts of vandalism
- Wear out of materials
- Firmware upgrades

Akse reserves the right, at its discretion, to repair or substitute the faulty products  
The warranty is not applicable to the products that will result defective in consequence of a negligent and improper use or an operating procedure not contemplated in this manual.

### RETURN AND REPAIR FORMALITIES

Akse accepts the return of instruments for repair only when authorized in advance. The transport costs are at customer charge.

### RE-SHIPING OF REPAIRED PRODUCT

The terms for re-shipment of repaired products are ex-works, i.e. the transport costs are at customer charge.

Products returned as defective but found to be perfectly working by our laboratories, will be charged a flat fee to account for checking and testing time irrespective of the warranty terms.

### SAFETY

This instrument was manufactured and tested in compliance with IEC 61010 CAT III-300V, class 2 standards for operating voltages up to 300 VAC rms phase to neutral.

In order to maintain this condition and to ensure safe operation, the user must comply with the indications and markings contained in the following instructions:

- When the instrument is received, before starting its installation, check that it is intact and no damage occurred during transport.
- Before mounting, ensure that the instrument operating voltages and the mains voltage are compatible then proceed with the installation.
- The instrument power supply needs no earth connection.
- The instrument is not equipped with a power supply fuse; a suitable external protection fuse must be foreseen by the contractor.
- Maintenance and/or repair must be carried out only by qualified, authorized personnel
- If there is ever the suspicion that safe operation is no longer possible, the instrument must be taken out of service and precautions taken against its accidental use.
- Operation is no longer safe when:

- 1) There is clearly visible damage.
- 2) The instrument no longer functions.
- 3) After lengthy storage in unfavorable conditions.
- 4) After serious damage occurred during transport

The instruments must be installed in respect of all the local regulations.

### OPERATOR SAFETY

**Warning:** Failure to observe the following instructions may lead to a serious danger of death.

- During normal operation dangerous voltages can occur on instrument terminals and on voltage and current transformers. Energized voltage and current transformers may generate lethal voltages. Follow carefully the standard safety precautions while carrying out any installation or service operation.
- The terminals of the instrument must not be accessible by the user after the installation. The user should only be allowed to access the instrument front panel where the display is located.
- Do not use the digital outputs for protection functions nor for power limitation functions. The instrument is suitable only for secondary protection functions.
- The instrument must be protected by a breaking device capable of interrupting both the power supply and the measurement terminals. It must be easily reachable by the operator and well identified as instrument cut-off device.
- The instrument and its connections must be carefully protected against short-circuit.

**Precautions:** Failure to respect the following instructions may irreversibly damage to the instrument.

- The instrument is equipped with PTC current limiting device but a suitable external protection fuse should be foreseen by the contractor.
- The outputs and the options operate at low voltage level; they cannot be powered by any unspecified external voltage.
- The application of currents not compatible with the current inputs levels will damage to the instrument.

Further documentation may be downloaded from our web site [www.electrex.it](http://www.electrex.it).

This document is owned by company AKSE that reserves all rights.

### DECLARATION OF CONFORMITY

Akse hereby declares that its range of products complies with the following directives EMC 89/336/EEC 73/23CE 93/68 CE and complies with the following product's standard CEI EN 61326 – IEC 61326 CEI EN 61010 – IEC 1010.  
The product has been tested in the typical wiring configuration and with peripherals conforming to the EMC directive and the LV directive.

The instrument is programmed with the following default values:

PAGE	MENU DISPLAYED	AVAILABLE PARAMETERS	DEFAULT
<b>PASSWORD REQUESTED</b>		0000 ... 9999	0000
<b>RS485</b>			
	RS 485 ADDRESS	1 ... 247	27
	Comm. Speed	2400, 4800, 9600, 19200, 38400	38400
	Data Bit	7 o 8	8
	Parity	N = no parity, E = peer parity, O = odd parity	N
	Bit of stop	1 o 2	2
<b>NETWORK</b>			
	Export	NO, YES	NO
	I FS	1 ... 10000	00010
	SHUNT	60 o 100	60
	VR	400000/999	1/1
<b>AVG-MD TIME (note n.2)</b>			
	POWERS	1...60 (minutes)	15
	CURRENTS	1...60 (minutes)	8
<b>ALARM 1 / A (note n.11)</b>			
	MODE (note n.3)	Normal, DERIV	NORMAL
	TYPE (note n.4)	MAX, MIN	MIN
	MEAS (note n.5)	Controlled measure. See table n.1 for register selection.	200
	THRE (note n.5)	Valore soglia	0
<b>ALARM 1 / B</b>			
	HYST	1...100 (%)	1
	DELAY	1...99 (seconds)	1
	AVG (note n.6)	1...99 (seconds)	1
	OUT (note n.7)	Normal, Hold, Pulse-L, Pulse-S	NORMAL
<b>ALARM 2 / A (note n.11)</b>			
	MODE (note n.3)	Normal, DERIV	NORMAL
	TYPE (note n.4)	MAX, MIN	MIN
	MEAS (note n.5)	Controlled measure. See table n.1 for register selection.	200
	THRE (note n.5)	Valore soglia	0
<b>ALARM 2 / B</b>			
	HYST	1...100 (%)	1
	DELAY	1...99 (seconds)	1
	AVG (note n.6)	1...99 (seconds)	1
	OUT (note n.7)	Normal, Hold, Pulse-L, Pulse-S	NORMAL
<b>ALARM 3 / A (note n.11)</b>			
	MODE (note n.3)	Normal, DERIV	NORMAL
	TYPE (note n.4)	MAX, MIN	MIN
	MEAS (note n.5)	Controlled measure. See table n.1 for register selection.	200
	THRE (note n.5)	Valore soglia	0
<b>ALARM 3 / B</b>			
	HYST	1...100 (%)	1
	DELAY	1...99 (seconds)	1
	AVG (note n.6)	1...99 (seconds)	1
	OUT (note n.7)	Normal, Hold, Pulse-L, Pulse-S	NORMAL
<b>ALARM 4 / A (note n.11)</b>			
	MODE (note n.3)	Normal, DERIV	NORMAL
	TYPE (note n.4)	MAX, MIN	MIN
	MEAS (note n.5)	Controlled measure. See table n.1 for register selection.	200
	THRE (note n.5)	Valore soglia	0
<b>ALARM 4 / B</b>			
	HYST	1...100 (%)	1
	DELAY	1...99 (seconds)	1
	AVG (note n.6)	1...99 (seconds)	1
	OUT (note n.7)	Normal, Hold, Pulse-L, Pulse-S	NORMAL
<b>DIGITAL OUT 1 (note n.8)</b>			
	MODE	PULSE, ALARM, REMOTE	PULSE
	POLARITY	NO, NC	NO
<b>PULSE OUT 1</b>			
	MEAS (note n.9)	P-IMP, P-EXP	P-IMP
	PRIMARY (note n.10)	YES, NO	YES
	WEIGHT	1...100000000 (Wh/100)	100000
	WIDTH	50ms...1S	500
<b>DIGITAL OUT 2 (note n.8)</b>			
	MODE	PULSE, ALARM, REMOTE	PULSE
	POLARITY	NO, NC	NO
<b>PULSE OUT 2</b>			
	MEAS (note n.9)	P-IMP, P-EXP	P-EXP
	PRIMARY (note n.10)	YES, NO	YES
	WEIGHT	1...100000000 (Wh/100)	100000
	WIDTH	50ms...1S	500

MECHANICAL CHARACTERISTICS	
Enclosure	Self-extinguishing plastic material class V0
Protection degree	IP40 on front panel
Dimensions	70 x 90 x 58 mm (4 DIN modules)
VOLTAGE INPUT	
Direct	Fino a 300 V max 360 V
Power supply	230/240Vac +/- 10% 50/60Hz
Self consumption	< 3VA
MODELS	
PFA7481-02	ATTO D4 DC 3I RS485 230-240V TRANSDUCER / ANALYZER
PFA7481-12	ATTO D4 DC 3I RS485 230-240V 1DI 2DO TRANSDUCER / ANALYZER

Holding Registers			
Address	n° Register	Type	Description
100	2	I	Primary VT
102	1	I	Secondary VT
103	1	I	Primary CT (Not used if version 70A)
104	1	I	Secondary CT (Current full scale if version 70A)
105	1	B	Insertion mode
106	1	I	Integration Time for Power
107	1	I	Integration Time for Current
109	1	B	Life Timer 2 (partial)
110	1	B	Energy Counters set 1 (totals)
111	1	B	Energy Counters set 2 (partials)
128	1	I	Total counters set symbol
129	1	I	Partial counters set symbol
135	1	I	Pulse output 1 measure selection
136	1	I	Pulse length output 1
137	2	I	Pulse weight output 1
139	1	I	Pulse output 2 measure selection
140	1	I	Pulse length output 2
141	2	I	Pulse weight output 2
155	1	B	Configuration DO1
156	1	B	Configuration DO 1
159	1	I	Measure selection alarm 1
160	1	I	Alarm 1 Mode
161	1	I	Logic combination alarm 1
162	1	I	Integration time alarm 1
163	1	I	Alarm 1 hysteresis
164	1	I	Alarm 1 delay
165	2	F	Alarm 1 threshold
167	1	I	Measure selection alarm 2
168	1	I	Mode alarm 2
169	1	I	Logic combination alarm 2
170	1	I	Integration time alarm 2
171	1	I	Alarm 2 hysteresis
172	1	I	Alarm 2 delay
173	2	F	Alarm 2 threshold
215	1	I	Serial transmission delay
216	1	B	Serial port: swap flags
217	1	I	Serial port: comm. speed
221	1	B	Output command
223	1	B	Combined Alarm Status
226	1	I	Instrument Reset

230	1	B	Reset counters set 1 (totals)
231	1	B	Reset counters set 2 (partials)
232	1	B	Reset counters phase 1
233	1	B	Reset counters phase 2
234	1	B	Reset counters phase 3
235	1	B	Reset AVG powers
236	1	B	Reset MD powers
237	1	B	Reset AVG currents
238	1	B	Reset MD currents
239	1	B	Reset min/max Us
240	1	B	Reset min/max Ud
241	1	B	Reset min/max I
242	1	B	Reset min/max Pimp
243	1	B	Reset min/max Pexp

F	Float IEEE754
I	Integer
B	Bitmapped

INPUT REGISTERS					
Address	n° Register	Type	Description	Symbol	Unit
220	2	F	Phase to Neutral Voltage, RMS Amplitude	U1N	[V]
232	2	F	Phase Current, RMS Amplitude	I1	[A]
240	2	F	Phase Active Power (+/-)	P1	[W]
284	2	F	Internal Temperature, °C	T	[°C]
286	2	F	Internal Temperature, °F	T	[°F]
288	2	F	Phase to Neutral Voltage, RMS Amplitude, MIN	U1N MIN	[A]
294	2	F	Phase to Neutral Voltage, RMS Amplitude, MAX	U1N MAX	[A]
312	2	F	Phase Current, RMS Amplitude, MAX	I1 MAX	[A]
320	2	F	Phase Active Power, Import, MAX	P1+ MAX	[A]
326	2	F	Phase Active Power, Export, MAX	P1- MAX	[A]
332	2	F	Phase Current, RMS Amplitude, AVG	I1 AVG	[A]
338	2	F	Phase Current, RMS Amplitude, MD	I1 MD	[A]
344	2	F	Total imported active power, AVG	P+ AVG	[W]
352	2	F	Total exported active power, AVG	P- AVG	[W]
360	2	F	Total imported active power, MD	P+ MD	[W]
368	2	F	Total exported active power, MD	P- MD	[W]
376	2	F	External Pulse Counter, With Weight, Total counter or Tariff T1	CNT1 S	
384	2	F	External Pulse Counter, With Weight, Partial Counter or Tariff T2	CNT1 P	
392	2	I	External Pulse Counter, Total counter or Tariff T1	CNT1 S	[-]
400	2	I	Lifetimer, Total counter	TIME S	[s]
402	2	I	External Pulse Counter, Partial Counter or Tariff T2	CNT1 P	[-]
410	2	I	Lifetimer, Partial Counter or Conditional Counter	TIME P	[s]
428	2	I	Total imported active energy, Partial Counter or Tariff T2	Ea P +	[kWh/10]
436	2	I	Total exported active energy, Partial Counter or Tariff T2	Ea P -	[kWh/10]
492	1	B	Digital Inputs Status	DI	[-]
494	1	B	Alarms Status (simple)	ALS	[-]
495	1	B	Alarms Status (combined)	ALC	[-]
528	4	I	Total imported active energy, Partial Counter or Tariff T2	Ea P +	[Wh/10]
544	4	I	Total exported active energy, Partial Counter or Tariff T2	Ea P -	[Wh/10]

<b>NOTE n.2</b>	
POWERS	Integration time of the average value (AVG) and max. value (MD) for power (from 1 to 60 minutes)
CURRENTS	Tempo di integrazione del valore medio (AVG) e di punta (MD) per la corrente (da 1 a 60 minuti)
<b>NOTE n.3</b>	
NORMAL	Classic alarm with reference to a fixed or max / min threshold, with applicable hysteresis and delay. The "AVG" parameter is not used.
DERIV	The "THRE" parameter becomes a percentage value. The instantaneous value applied to the alarm on "MEAS" will be compared with its averaged value obtained depending on the time set on "AVG". When the instantaneous value combined to the alarm differs in "more then" (if set "MAX") or in "less then" (if set "MIN") compared to the average value ("AVG") of the percentage set on "THRE", the alarm triggers. With applicable hysteresis and delay. The "AVG" parameter is used.
<b>NOTE n.4</b>	
MAX	Alarm configuration in "excess" according to the conditions set. Except the "UNBAL" mode.
MIN	Alarm configuration "decreasing" according to the conditions set. Except the "UNBAL" mode.
<b>NOTE n.5</b>	
MEAS	Indicates on which register (and on which measure) the alarm is reported. See table n.1 (Input Register).
THRE	Alarm threshold in absolute value, except the "DERIV" value where the value inserted becomes a percentage.
<b>NOTE n.6</b>	
AVG	Parameter to be used in the sole "DERIV" mode. Floating window amplitude ( in seconds) used for creating a reference value to which compare the instantaneous value.
<b>NOTE n.7</b>	
NORMAL	The output remains exited during all the alarm, after all it falls.
HOLD	The output remains exited until the manual reset made through Modbus
PULSE-L	The output generates a 500ms pulse on the alarm triggering.
PULSE-S	The output generates a 100ms pulse on the alarm triggering.
<b>NOTE n.8</b>	
PULSE	Enables output function as impulsive
ALARM	Enables output function as alarm
REMOTE	Enables output function through Modbus Protocol
NO	Normally open
NC	Normally closed
<b>NOTE n.9</b>	
P-IMP	Imported Active Power (Energy)
QL-IMP	Imported Inductive Reactive Power (Energy)
QC-IMP	Imported Capacitive Reactive Power (Energy)
S-IMP	Imported Apparent Power (Energy)
P-EXP	Exported Active Power (Energy)
QL-EXP	Exported Inductive Reactive Power (Energy)
QC-EXP	Exported Capacitive Reactive Power (Energy)
S-EXP	Exported Apparent Power (Energy)
<b>NOTE n.10</b>	
YES	Referred to the primary of the CT
NO	Referred to the secondary of the CT
<b>NOTE n.11</b>	
ALLARME 1	Alarm associated to the physic output DIGITAL OUT 1 (DO1, terminal 8)
ALLARME 2	Alarm associated to the physic output DIGITAL OUT 2 (DO2, terminal 9)
ALLARME 3	MODBUS only alarm
ALLARME 4	MODBUS only alarm

## ALARM SETTING EXAMPLES

In order that the output "DIGITAL OUT 1" gets excited and remains such during all the alarm (latching): when the Average Active Power (MEAS 344) exceeds the value of 100 kW, hysteresis 5% and delay of 5 seconds, set the parameters as in the table below:

<b>ALARM 1 / A</b>	MODE (note n.2)	Normal, DERIV	NORMAL
	TYPE (note n.3)	MAX, MIN	MAX
	MEAS (note n.4)	Controlled measure. See table n.1 for the register selection	344
	THRE (note n.4)	Threshold value	100000
<b>ALARM 1 / B</b>	HYST	1...100 (%)	5
	DELAY	1...99 (seconds)	5
	AVG (note n.5)	1...99 (seconds)	1
	OUT (note n.6)	Normal, Hold, Pulse-L, Pulse-S	NORMAL
<b>DIGITAL OUT 1</b>	MODE	PULSE, ALARM, REMOTE	ALARM
	POLARITY	NO, NC	NO

In order that the output "DIGITAL OUT 1" gets excited and remains such during all the alarm (latching): when the Average Active Power (MEAS 344) falls below the value of 90 kW, hysteresis 5% and delay of 5 seconds, set the parameters as in the table below:

<b>ALARM 2 / A</b>	MODE (note n.2)	Normal, DERIV	NORMAL
	TYPE (note n.3)	MAX, MIN	MIN
	MEAS (note n.4)	Controlled measure. See table n.1 for the register selection	344
	THRE (note n.4)	Threshold value	90000
<b>ALARM 2 / B</b>	HYST	1...100 (%)	5
	DELAY	1...99 (seconds)	5
	AVG (note n.5)	1...99 (seconds)	1
	OUT (note n.6)	Normal, Hold, Pulse-L, Pulse-S	NORMAL
<b>DIGITAL OUT 2</b>	MODE	PULSE, ALARM, REMOTE	ALARM
	POLARITY	NO, NC	NO

## VOLTAGE AND CURRENT CONNECTION

### Voltage connection:

Use cables with max cross-section of 2,5 mm<sup>2</sup> if stranded 4 mm<sup>2</sup> if rigid and connect them to the terminals marked VOLTAGE INPUT on the instrument according to the applicable diagrams that follow.

### Current connection:

Use SHUNT with adequate primary and 60 or 100 mV as secondary rate. Connect the SHUNT to the terminals marked I1 (S1 e S2) (current input) according to the applicable diagrams that follow.

### SHUNT CONNECTION

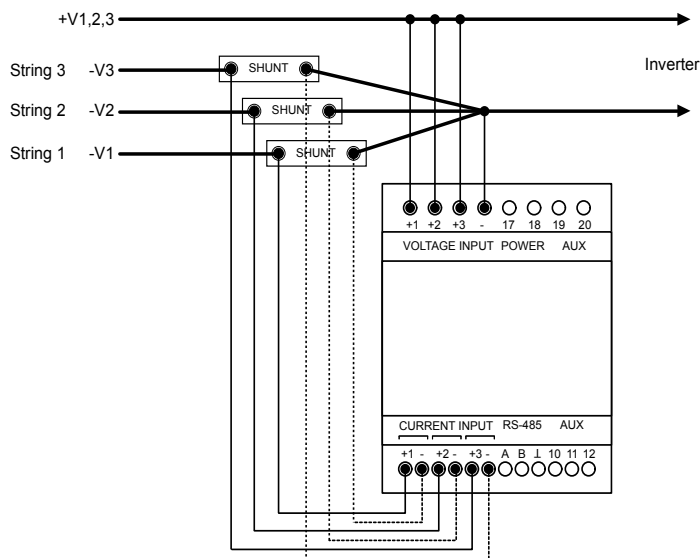

### ATTENTION

The shunt's resistance has a range of mohm, here below you can find some resistance values related to different models of shunts.

PRIMARY (A)	SECONDARY (mV)	RESISTANCE(mohm)
5	60	12
10	60	6
25	60	2,4
100	100	1

The length of the connections and the serial insertion of protection devices (fuses, switchers, etc.), can distort the measurement results.

### POWER SUPPLY AND SERIAL LINE CONNECTION

The instrument is fitted with a separate power supply. The power supply terminals are numbered (17) and (18). Use cables with max cross-section of 2,5 mm<sup>2</sup> if stranded, 4 mm<sup>2</sup> if rigid

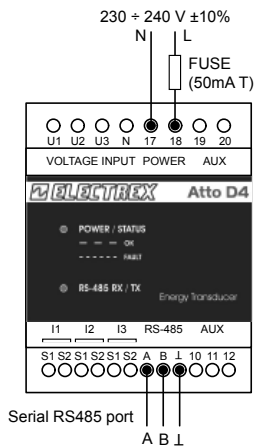

### DIGITAL INPUT & OUTPUT CONNECTION

(only for version PFA7481-12)

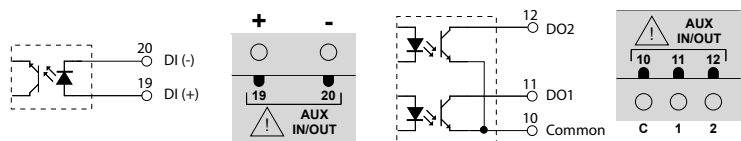

Digital Inputs	
Supply voltage (external):	from 10 to 30 Vdc
Current consumption:	from 2 to 10mA
Max. count frequency	10 or 100Hz
N.B. For gas meters a galvanic separation is needed per ATEX standards	

Digital outputs (optocoupled NPN transistor type for DIN 43864)	
Maximum applicable voltage:	27 Vdc
Maximum switchable current:	27 mA

### PRECAUTIONS FOR NOT ALTERING THE MEASUREMENTS

- 1) The wire's length from the shunt's output terminal (1,2,3) to the junction point (4) must be the shortest possible (lower than 100cm);
- 2) The wires should have the same length;

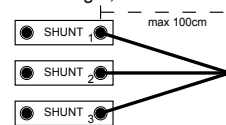

- 3) The shunt and the instrument should be installed, preferably, within the same or in adjacent panels.

- 4) Important:

- Do not insert fuses in the shunt's output: the fuse has a resistance and it is not the same for all the fuses;
- Do not insert breakers in the shunt's output: the contact surface of the breaker generates a resistance;
- Do not insert diodes in the shunt's output;

The presence of fuses, breakers or diodes before the input of the shunt does not generate measurement distortion.

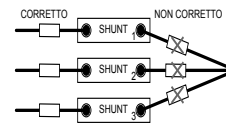

- 5) Do not make any bridge connection on the shunt outputs. In the example here below the resistance between the points 1-4 and 3-4 results higher than the one between the points 2-4, because the bridge's resistances is added too.

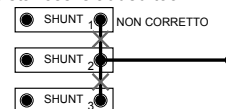

- 6) The wire's length from the point (4) and the "-" input of the instrument must not be higher than 100cm.

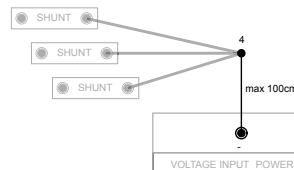

- 7) The shunts must be connected on the negative pole.

### EXAMPLE OF DIGITAL INPUT & OUTPUT CONNECTION

