

DECA SENSOR

INSTALLATION GUIDE

COPYRIGHT

Electrex is a trademark of Akse S.r.l. All rights reserved.

It is forbidden to duplicate, adapt, transcript this document without Akse written authorization, except when regulated accordingly by the Copyright Laws.

WARRANTY

This product is covered by a warranty against material and manufacturing defects for a 24 months period from the manufacturing date.

The warranty does not cover the defects that are due to:

- Negligent and improper use
- Failures caused by atmospheric hazards
- Acts of vandalism
- Wear out of materials
- Firmware upgrades

Akse reserves the right, at its discretion, to repair or substitute the faulty products

The warranty is not applicable to the products that will result defective in consequence of a negligent and improper use or an operating procedure not contemplated in this manual.

RETURN AND REPAIR FORMALITIES

Akse accepts the return of instruments for repair only when authorized in advance. The transport costs are at customer charge.

RE-SHIPING OF REPAIRED PRODUCT

The terms for re-shipment of repaired products are ex-works, i.e. the transport costs are at customer charge.

Products returned as defective but found to be perfectly working by our laboratories, will be charged a flat fee to account for checking and testing time irrespective of the warranty terms.

SAFETY

This instrument was manufactured and tested in compliance with IEC 61010-1 CAT III-300V class 2 standards for exercise voltages up to 300 Vac rms phase to neutral.

In order to maintain this condition and to ensure safe operation, the user must comply with the indications and markings contained in the following instructions:

- When the instrument is received, before starting its installation, check that it is intact and no damage occurred during transport.
- Before mounting, ensure that the instrument operating voltages and the mains voltage are compatible then proceed with the installation.
- The instrument power supply needs no earth connection.
- The instrument is not equipped with a power supply fuse; a suitable external protection fuse must be foreseen by the contractor.
- Maintenance and/or repair must be carried out only by qualified, authorized personnel
- If there is ever the suspicion that safe operation is no longer possible, the instrument must be taken out of service and precautions taken against its accidental use.
- Operation is no longer safe when:

- 1) There is clearly visible damage.
- 2) The instrument no longer functions.
- 3) After lengthy storage in unfavorable conditions.
- 4) After serious damage occurred during transport

The instruments must be installed in respect of all the local regulations.

OPERATOR SAFETY

Warning: Failure to observe the following instructions may lead to a serious danger of death.

- During normal operation dangerous voltages can occur on instrument terminals and on voltage and current transformers. Energized voltage and current transformers may generate lethal voltages. Follow carefully the standard safety precautions while carrying out any installation or service operation.
- The terminals of the instrument must not be accessible by the user after the installation. The user should only be allowed to access the instrument front panel where the display is located.
- Do not use the digital outputs for protection functions nor for power limitation functions. The instrument is suitable only for secondary protection functions.
- The instrument must be protected by a breaking device capable of interrupting both the power supply and the measurement terminals. It must be easily reachable by the operator and well identified as instrument cut-off device.
- The instrument and its connections must be carefully protected against short-circuit.

Precautions: Failure to respect the following instructions may irreversibly damage to the instrument.

- The instrument is equipped with PTC current limiting device but a suitable external protection fuse should be foreseen by the contractor.
- The outputs and the options operate at low voltage level; they cannot be powered by any unspecified external voltage.
- The application of currents not compatible with the current inputs levels will damage to the instrument.

Further documentation may be downloaded from our web site www.electrex.it

This document is owned by the company AKSE that reserves all rights.

DECLARATION OF CONFORMITY

Akse hereby declares that its range of products complies with the following directives EMC 89/336/EEC 73/23CE 93/68 CE and complies with the following product's standard CEI EN 61326 – IEC 61326 CEI EN 61010 – IEC 61010.

The product has been tested in the typical wiring configuration and with peripherals conforming to the EMC directive and the LV directive.

The instrument is configured with the following default values:

PAGE	MENU DISPLAYED	AVAILABLE PARAMETERS	DEFAULT
MODBUS COMMUNICATION			
	RS485 ADDRESS	1 ... 247	27
E-Wi WIRELESS VERSION			
	Sampling time	1...15	1
	Radio Wave (wireless) channel	11...26	11
	Rendezvous time	30s - 1,5,10,15 min - 1,2,4,6,12,24 h	15 min
	Radio module power version	LO, HI	HI
	Instrument modality	RFD, FFD	RFD
RS485 VERSION			
	Baud rate	4800, 9600, 19200, 38400	38400
	Bit Data	8	8
	Parity	N = no parity	N
	Bit of stop	2	2
ALARMS 1,2,3,4			
	Alarm 1 measure selection	IR register address to which the alarm is related.	4
	Alarm 1 mode	Min, Max	Max
	Alarm 1 HYST	0-99 %	5
	Alarm 1 DELAY	0-29999 s	5
	Alarm 1 THRESHOLD		0
Offset/GAIN TEMP, HUM, LUX, TE, EXT 1,2,3,4			
	Offset		0
	Gain		1
INPUT COUNTERS WEIGHT 1,2,3,4			
	Counter weight		1

MECHANICAL CHARACTERISTICS	
Enclosure	ABS Self-extinguishing
Size	80 x 80 x 25 mm
POWER SUPPLY	
BATTERY	
Type	Lithium-thionyl chloride (Li-SOCl ₂)
Format	AA size
Nominal capacity	2,6 Ah
Nominal voltage	3,6 V
Operating temperature	-60/+85 °C
EXTERNAL	
Voltage	5 V
MODELS	
PFATUTH-0B	DECA SENSOR E-WI HI T BATTERY
PFATUHH-0B	DECA SENSOR E-WI HI T H BATTERY
PFATULH-0B	DECA SENSOR E-Wi HI T H L BATTERY
PFATUTH-NB	DECA SENSOR E-Wi HI T 4DI TE BUS BATTERY 5V
PFATUHH-NB	DECA SENSOR E-Wi HI T H 4DI TE BUS BATTERY 5V
PFATULH-NB	DECA SENSOR E-Wi HI T H L 4DI TE BUS BATTERY 5V
PFATULH-QB	DECA SENSOR E-WI HI T H L 2DI 2DO TE BUS BATTERY 5V
PFATULH-PB	DECA SENSOR E-WI HI T H L 4DO TE BUS BATTERY 5V
PFATUT1-0C	DECA SENSOR RS485 T 5V
PFATUH1-0C	DECA SENSOR RS485 T H 5V
PFATUL1-0C	DECA SENSOR RS485 T H L 5V
PFATUT1-NC	DECA SENSOR RS485 T 4DI TE BUS 5V
PFATUH1-NC	DECA SENSOR RS485 T H 4DI TE BUS 5V
PFATUL1-NC	DECA SENSOR RS485 T H L 4DI TE BUS 5V
PFATUL1-QC	DECA SENSOR RS485 T H L 2DI 2DO TE BUS 5V
PFATUL1-PC	DECA SENSOR RS485 T H L 4DO TE BUS 5V
PFAT0TS-01	DECA SENSOR EXTERNAL TE1
PFAT0TS-02	DECA SENSOR EXTERNAL TE2
PFAT0TS-03	DECA SENSOR EXTERNAL TE3
PFATVTQ-00	DECA SENSOR BUS UNIT BOX T
PFATVHQ-00	DECA SENSOR BUS UNIT BOX T H
PFATVOQ-00	DECA SENSOR BUS UNIT BOX T L
PFATVLQ-00	DECA SENSOR BUS UNIT BOX T H L
PFATVRQ-00	DECA SENSOR BUS UNIT BOX T H L B
PFATVMQ-00	DECA SENSOR BUS UNIT BOX L
PFATVNQ-00	DECA SENSOR BUS UNIT BOX B
PFAT0TQ-00	DECA SENSOR BUS UNIT T 1
PFAT0TQ-01	DECA SENSOR BUS UNIT T 2
PFAT0MQ-00	DECA SENSOR BUS UNIT L
PFAT0IS-01	DECA SENSOR LED PULSE COUNTER
PFAT000-01	LED PULSE C. MOUNTING BRACKET
PFATV01-00	DECA SENSOR OPTION MODULE RS485 5V
PFAT000-0B	DECA SENSOR LITHIUM BATTERY
PFTP000-R2	SWITCHING POWER SUPPLY 5VDC 600mA
PFAT0T0-01	DECA SENSOR EXTERNAL ENCLOSURE

MODBUS COMMUNICATION PROTOCOL

Holding Registers				
Address	n° Register	Type	Description	Value
0	1	I	Alarm 1 measure selection	IR register address to which the alarm is related.
1	1	I	Alarm 1 mode	Bit 0-3 = Alarm channels logic port A input Bit 4 = Direction (polarity): 0 = Min (neg if derived) 1 = Max (pos if derived) Bit 8-11 = Alarm channels logic port B input Bit 12-14 = Output logic selection Bit 12 = Output port operator 0 out = A or B 1 out = A and B Bit 13 = Port A Operator (0=OR, 1=AND) Bit 14 = Port B Operator (0=OR, 1=AND)
2	1	I	Alarm 1 hysteresis	0-99 %
3	1	I	Alarm 1 delay	0-29999 s
4	2	F	Alarm 1 threshold	
6	1	I	Alarm 2 measure selection	IR register address to which the alarm is related.
7	1	I	Alarm 2 mode	same as in Alarm mode 1
8	1	I	Alarm 2 hysteresis	0-99 %
9	1	I	Alarm 2 delay	0-29999 s
10	2	F	Alarm 2 threshold	
12	1	I	Alarm 3 measure selection	IR register address to which the alarm is related.
13	1	I	Alarm 3 mode	same as in Alarm mode 1
14	1	I	Alarm 3 hysteresis	0-99 %
15	1	I	Alarm 3 delay	0-29999 s
16	2	F	Alarm 3 threshold	
18	1	I	Alarm 4 measure selection	IR register address to which the alarm is related.
19	1	I	Alarm 4 mode	same as in Alarm mode 1
20	1	I	Alarm 4 hysteresis	0-99 %
21	1	I	Alarm 4 delay	0-29999 s
22	2	F	Alarm 4 threshold	
24	2	F	Offset temp	
26	2	F	Gain temp	
28	2	F	Offset hum	
30	2	F	Gain hum	
32	2	F	Offset lum.	
34	2	F	Gain lum.	
36	2	F	Offset ntc	
38	2	F	Gain ntc	
40	2	F	Offset ext1	
42	2	F	Gain ext1	
44	2	F	Offset ext2	
46	2	F	Gain ext2	
48	2	F	Offset ext3	
50	2	F	Gain ext3	
52	2	F	Offset ext4	
54	2	F	Gain ext4	
56	1	B	Measure Configuration temp	Bits 0:7 = measurement config.: 0 = no measurement; 1 = instantaneous measurement; 2 = floating window average; 3 = median. Bits 8:15 = time window samples number, max 15
57	1	B	Measure Configuration hum	same as above
58	1	B	Measure Configuration lum.	same as above
59	1	B	Measure Configuration ntc	same as above
60	1	B	Measure Configuration ext1	same as above
61	1	B	Measure Configuration ext2	same as above
62	1	B	Measure Configuration ext3	same as above
63	1	B	Measure Configuration ext4	same as above
64	1	B	Rendezvous time (seconds)	
65	1	B	Sampling time (submultiple of the Rendezvous time) / Channel radio	Bits 0:7 = Sampling time (Number of measurements and alarm checking made by the instruments, within the period between two rendezvous); Bits 8:15 = Radio wave Channel (Band around the 2,4 Ghz used for the communication: Min 11, Max 26) Significant only for wireless versions
66	1	B	Instrument configuration	Bits 0:1 = 2; Bits 6:7 = Serial baud rate 485 (Only for the RS485 versions) 0 = 9600; 1 = 19200; 2 = 38400; 3 = 4800; Bit 11 = Radio module power selection (only for the wireless versions): 0 = reduced power; 1 = high power; Bit 13 = Reset instrument to factory default; Bit 14 = Reboot instrument; Bit 15 = Change instrument modality (from RFD to FFD or from FFD to RFD) (only for the wireless versions)
67	1	B	AVD, MIN, MAX reset	Bit 0 = reset AVG, MIN and MAX measurement temp Bit 1 = reset AVG, MIN and MAX measurement hum Bit 2 = reset AVG, MIN and MAX measurement lum. Bit 3 = reset AVG, MIN and MAX measurement NTC Bit 4 = reset AVG, MIN and MAX measurement external1 Bit 5 = reset AVG, MIN and MAX measurement external2 Bit 6 = reset AVG, MIN and MAX measurement external3 Bit 7 = reset AVG, MIN and MAX measurement external4 Bit 8 = reset counter1 Bit 9 = reset counter2 Bit 10 = reset counter3 Bit 11 = reset counter4
68	2	F	Counter weight 1	
70	2	F	Counter weight 2	
72	2	F	Counter weight 3	
74	2	F	Counter weight 4	

INPUT REGISTERS					
Address	n° Register	Type	Description	Unit	Note
0	2	I	Timestamp WALL		Significant only for the wireless versions
2	1	B	Alarm state		Bit 0: alarm state 1 Bit 1: alarm state 2 Bit 2: alarm state 3 Bit 3: alarm state 4 Bit 4: alarm state battery level Bit 6: indication state RFD/FFD Bit 8: alarm state combined 1 Bit 9: alarm state combined 2 Bit 10: alarm state combined 3 Bit 11: alarm state combined 4
3	1	I	Battery charge %	%	Significant only for the wireless versions
4	2	F	Value temp	°C	
6	2	F	Value hum	%	
8	2	F	Value lum.	Lux	
10	2	F	Value ntc		
12	2	F	Value ext1		
14	2	F	Value ext2		
16	2	F	Value ext3		
18	2	F	Value ext4		
20	2	I	Value counter1 int		
22	2	I	Value counter2 int		
24	2	I	Value counter3 int		
26	2	I	Value counter4 int		
28	2	F	Value temp AVG	°C	
30	2	F	Value hum AVG	%	
32	2	F	Value lum. AVG	Lux	
34	2	F	Value ntc AVG	°C	
36	2	F	Value temp min	°C	
38	2	F	Value hum min	%	
40	2	F	Value lum. min	Lux	
42	2	F	Value ntc min	°C	
44	2	F	Value temp max	°C	
46	2	F	Value hum max	%	
48	2	F	Value lum. max	Lux	
50	2	F	Value ntc max	°C	
52	2	F	Value ext1 AVG		
54	2	F	Value ext2 AVG		
56	2	F	Value ext3 AVG		
58	2	F	Value ext4 AVG		
60	2	F	Value ext1 min		
62	2	F	Value ext2 min		
64	2	F	Value ext3 min		
66	2	F	Value ext4 min		
68	2	F	Value ext1 max		
70	2	F	Value ext2 max		
72	2	F	Value ext3 max		
74	2	F	Value ext4 max		
76	2	F	Value counter1 weighted		
78	2	F	Value counter2 weighted		
80	2	F	Value counter3 weighted		
82	2	F	Value counter4 weighted		

F	Float IEEE754
I	Integer
B	Bitmapped

SERIAL RS 485 INTERFACE CONNECTION

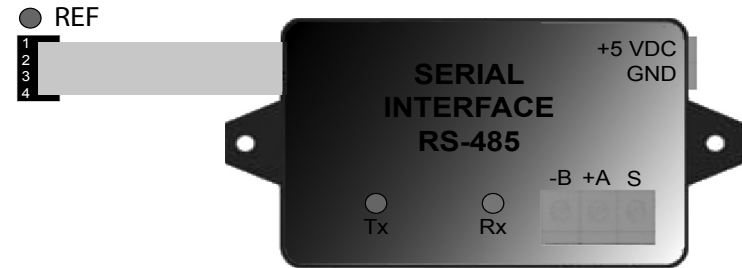
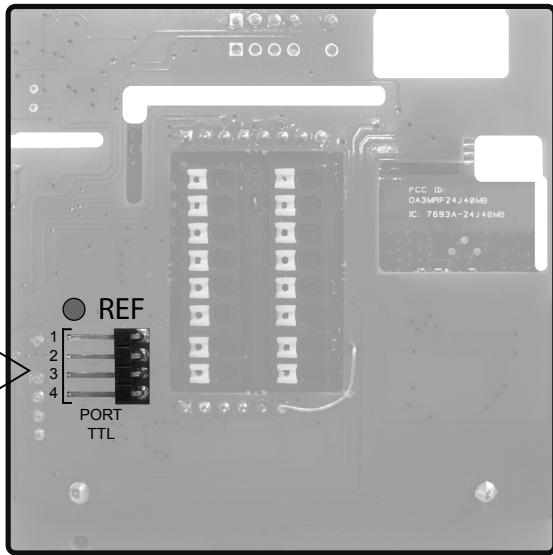

PIN	DESCRIPTION
S	Shield
A	A +
B	B -

NOTE

POWER SUPPLY OPTION RS-485

The RS-485 interface must be powered through its own terminals (VDC, GND). The interface's power supply will power also the DECA Sensor instrument. The use of the proper power supply, code PFTP0000-R2, is recommended.

RS-485 INTERFACE ACTIVATION

In order to use and manage the configuration of the interface may be necessary to update the firmware of the instrument. The update can be made via the Energy Brain software.

INSTRUMENT STARTING STATE	UPDATE	INSTRUMENT FINAL STATE
DECA E-Wi	Firmware RS-485	DECA RS-485
DECA RS-485	Firmware E-Wi	DECA E-Wi

INTERNAL MODULES DECA SENSOR

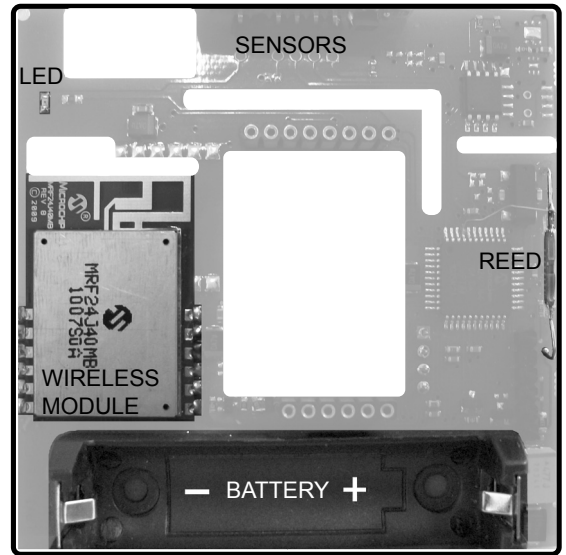

BATTERY

The battery life can vary from days to years depending on the time of rendezvous set in the instrument and the number of interfaces connected to it.

REED

Placing a magnet to the reed will cause the rendezvous with the E-Wi network. This will avoid to have to wait or change the time of rendezvous set in the instrument configuration.

SENSORS

Board on which are mounted internal temperature, humidity and luminosity sensors.

WIRELESS MODULE

Where present add the feature of a wireless connection to an E-Wi network. If not present, the communication must be made through the option RS-485 connected to the TTL port.

BOARD CONNECTION

BUS UNIT



CONNECTION

VCC	Orange
SCL	White Orange
SDA	Green
GND	White Green

MODELS

PFATVTQ-00	DECA SENSOR BUS UNIT BOX T
PFATVHQ-00	DECA SENSOR BUS UNIT BOX T H
PFATVOQ-00	DECA SENSOR BUS UNIT BOX T L
PFATVLQ-00	DECA SENSOR BUS UNIT BOX T H L
PFATVRQ-00	DECA SENSOR BUS UNIT BOX T H L B
PFATVMQ-00	DECA SENSOR BUS UNIT BOX L
PFATVNQ-00	DECA SENSOR BUS UNIT BOX B
PFAT0TQ-00	DECA SENSOR BUS UNIT T 1
PFAT0TQ-01	DECA SENSOR BUS UNIT T 2
PFAT0MQ-00	DECA SENSOR BUS UNIT L

LED PULSE COUNTER MOUNTING BRACKET - ONLY FOR GEM/GET METERS



MODELS

PFAT000-01	DECA SENSOR LED PULSE C. MOUNTING BRACKET
------------	---

LED PULSE COUNTER



CONNECTION

VCC (+)	Brown
GND (-)	White

MODELS

PFAT0IS-01	DECA SENSOR LED PULSE COUNTER
------------	-------------------------------

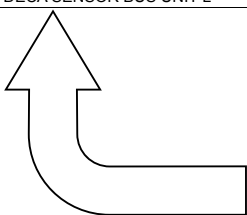

EXTERNAL TE



CONNECTION

NO polarity

MODELS

PFAT0TS-01	DECA SENSOR EXTERNAL TE1
PFAT0TS-02	DECA SENSOR EXTERNAL TE2
PFAT0TS-03	DECA SENSOR EXTERNAL TE3

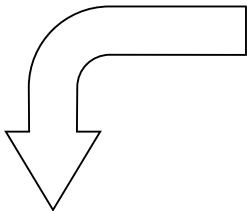
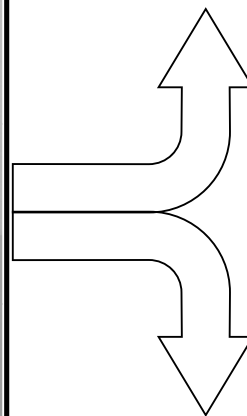
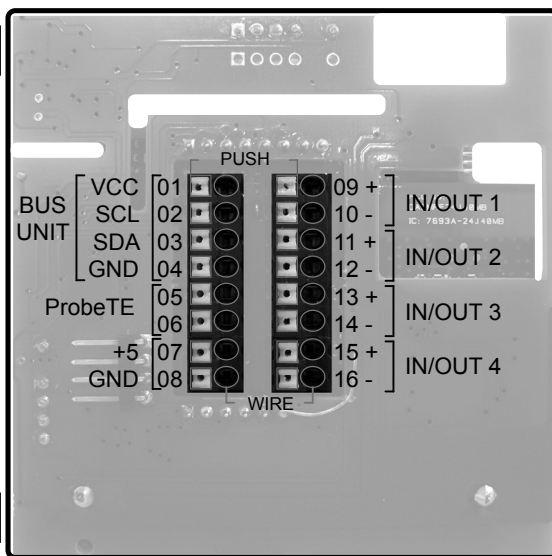

ATTENTION:

- 1) IN/AUX 1, IN/AUX 2, IN/AUX 3, IN/AUX 4 may be INPUTS or OUTPUTS DEPENDING ON THE PURCHASED MODEL/INSTRUMENT.
- 2) The inputs do have a common "-" negative pole.
- 3) The outputs are insulated from each other.

POWER SUPPLY External



CONNECTION

--	--

MODELS

PFTP000-R2	SWITCHING POWER SUPPLY 5VDC 600mA
------------	-----------------------------------

DIGITAL SELF POWERED INPUTS

Clear contact, Gas, Air, Water, Steam, etc. Meters



CONNECTION

Power supply voltage (external):	from 10 to 30 Vdc
Current absorbed :	from 2 to 10mA
Max. counting frequency:	100Hz

Note: for the gas counter, a galvanic insulated divider following ATEX normative, is needed.

DIGITAL OUTPUTS Opto-isolated transistor (NPN) according to standard DIN 43864.

CONNECTION

Maximum applicable voltage:	27 Vdc
Maximum switching current:	27mA