

96 RS485

INSTALLATION GUIDE

COPYRIGHT

Electrex is a trademark of Akse S.r.l. All rights reserved.
It is forbidden to duplicate, adapt, transcript this document without Akse written authorization, except when regulated accordingly by the Copyright Laws.

WARRANTY

This product is covered by a warranty against material and manufacturing defects for a 24 months period from the manufacturing date.

The warranty does not cover the defects that are due to:

- Negligent and improper use
- Failures caused by atmospheric hazards
- Acts of vandalism
- Wear out of materials
- Firmware upgrades

Akse reserves the right, at its discretion, to repair or substitute the faulty products

The warranty is not applicable to the products that will result defective in consequence of a negligent and improper use or an operating procedure not contemplated in this manual.

RETURN AND REPAIR FORMALITIES

Akse accepts the return of instruments for repair only when authorized in advance. The transport costs are at customer charge.

RE-SHIPING OF REPAIRED PRODUCT

The terms for re-shipment of repaired products are ex-works, i.e. the transport costs are at customer charge.

Products returned as defective but found to be perfectly working by our laboratories, will be charged a flat fee to account for checking and testing time irrespective of the warranty terms.

SAFETY

This instrument was manufactured and tested in compliance with IEC 61010-1 CAT III - 300V class 2 standards for operating voltages up to 300 VAC rms phase to neutral.

In order to maintain this condition and to ensure safe operation, the user must comply with the indications and markings contained in the following instructions:

- When the instrument is received, before starting its installation, check that it is intact and no damage occurred during transport.
- Before mounting, ensure that the instrument operating voltages and the mains voltage are compatible then proceed with the installation.
- The instrument power supply needs no earth connection.
- The instrument is not equipped with a power supply fuse; a suitable external protection fuse must be foreseen by the contractor.
- Maintenance and/or repair must be carried out only by qualified, authorized personnel
- If there is ever the suspicion that safe operation is no longer possible, the instrument must be taken out of service and precautions taken against its accidental use.

Operation is no longer safe when:

- There is clearly visible damaged.
- The instrument no longer functions.
- After lengthy storage in unfavorable conditions.
- After serious damage occurred during transport

The instruments must be installed in respect of all the local regulations.

OPERATOR SAFETY

Warning: Failure to observe the following instructions may lead to a serious danger of death.

- During normal operation dangerous voltages can occur on instrument terminals and on voltage and current transformers. Energized voltage and current transformers may generate lethal voltages. Follow carefully the standard safety precautions while carrying out any installation or service operation.
- The terminals of the instrument must not be accessible by the user after the installation. The user should only be allowed to access the instrument front panel where the display is located.
- Do not use the digital outputs for protection functions nor for power limitation functions. The instrument is suitable only for secondary protection functions.
- The instrument must be protected by a breaking device capable of interrupting both the power supply and the measurement terminals. It must be easily reachable by the operator and well identified as instrument cut-off device.
- The instrument and its connections must be carefully protected against short-circuit.

Precautions: Failure to respect the following instructions may irreversibly damage to the instrument.

- The outputs and the options operate at low voltage level; they cannot be powered by any unspecified external voltage.
- The application of currents not compatible with the current inputs levels will damage to the instrument.

Further documentation may be downloaded from our web site www.electrex.it.

This document is owned by company AKSE that reserves all rights.

DECLARATION OF CONFORMITY

Akse hereby declares that its range of products complies with the following directives EMC 2014/30/EU, 2014/35/EU and complies with the following product's standard CEI EN 61326 - Ed. 2.0 (2012) - IEC 61326 - Ed. 2.0 (2012) CEI EN 61010 Ed. 3 (2010) - IEC 61010 Ed. 3 (2010). The product has been tested in the typical wiring configuration and with peripherals conforming to the EMC directive and the LV directive.

READINGS



Keep pressed for 2 seconds to display:

- Type of instrument
- Firmware version
- Serial number
- RS485 address

MEASURE LIST TABLE

(The parameters available vary according to instrument configuration)

U	I	P/PF	CNT					
ULN	I	P		Ea + MAIN	Er + L MAIN	Es + MAIN	C1 MAIN	t MAIN
ULL	I Σ	P Σ		Ea - MAIN	Er - L MAIN	Es - MAIN	C2 MAIN	t P1
ULN THD	I THD	P AVG +		Ea + Fase	Er + C MAIN	Es + Fase	C3 MAIN	t P2
ULL THD	I MAX	P AVG -		Ea - Fase	Er - C MAIN	Es - Fase	C4 MAIN	t P3
ULN MIN	I AVG	P MD +		Ea + P1	Er + L Fase	Es + P1	C1 P1	t LIFE
ULL MIN	I MD	PMD -		Ea - P1	Er - L Fase	Es - P1	C2 P1	
ULN MAX		Q		Ea + P2	Er + C Fase	Es + P2	C3 P1	
ULL MAX		Q Σ		Ea - P2	Er - C Fase	Es - P2	C4 P1	
		Q AVG +		Ea + P3	Er + L P1	Es + P3	C1 P2	
		Q AVG -		Ea - P3	Er - L P1	Es - P3	C2 P2	
		Q MD +			Er + C P1		C3 P2	
		Q MD -			Er - C P1		C4 P2	
		S			Er + L P2		C1 P3	
		S Σ			Er - L P2		C2 P3	
		S AVG +			Er + C P2		C3 P3	
		S AVG -			Er - C P2		C4 P3	
		S MD +			Er + L P3			
		S MD -			Er - L P3			
		PF			Er + C P3			
		PF Σ			Er - C P3			

LEGEND OF PARAMETERS AND SYMBOLS

U	Voltage	THD	Total Harmonic Distortion
LN	Phase Neutral	AVG	Average (rolling) value
LL	Phase Phase	MD	Maximum Demand
I	Current	MIN	Minimum values (10 cycles time base)
In	Neutral current	MAX	Maximum values (10 cycles time base)
P	Active Power	+	Imported value
Q	Reactive Power	-	Exported value
S	Apparent Power	Er L	Inductive
PF	Power Factor	Er C	Capacitive
F	Frequency	t	Time counter
Ea	Active Energy	C	Pulse count
Er	Reactive Energy	MAIN	Total
Es	Apparent Energy	P1,P2,P3	Partial 1,2,3
		LIFE	Device lifetime

MECHANICAL CHARACTERISTICS

Case	Self-extinguishing plastic material class V0
Protection degree	IP40 on front panel, IP20 terminals side
Size	96 x 96 x 72 mm

VOLTAGE INPUTS

Direct insertion	Up to 300 Vrms phase-neutral or 520 Vrms phase to phase
With external VT:	Primary: programmable (max. 400 kV) Secondary: programmable (max. 300 V)
	Overload: 900 Vrms phase to phase for 1 sec
Aux. power supply	230/240Vac +/- 10% 50/60Hz
Self consumption:	< 2,5VA

MODELS

PFAEC11-D2-B

DEVICE SETUP

ENTER THE SETUP / SAVE		EXIT THE SETUP WITHOUT SAVING	
Push for 2 seconds	MENU ENTER	Push for 2 seconds	ESC

DESCRIPTION OF KEYS

	U ▲	I ▼	P/PF ◀	CNT ▶
Click	Modify parameter	Modify parameter	Go to previous value	Go to next value
Click 2 sec			Go to previous page	Go to next page

SETUP SEQUENCE

PAGE	PARAMETERS	VALUES AVAILABLE	DEFAULT
PASSWORD			
	PASSWORD	0000 ... 9999	0000
BASIC SETTINGS			
	WIRING (note n.1)	3P4W, 2P2W, 1P2W, 3I, 3P3W-B-3U, 3P4W-B-3U, 3P3W-B, 3P4W-B, 3P3W	3P4W
	QUADRANTS	2Q, 4Q	2Q
	CT PRIMARY	1...10000	00005
	CT SECONDARY	1...5	5
	VT PRIMARY	1...400000	000001
	VT SECONDARY	1...999	001
	P-AVG WINDOW (note n.2)	1...60 (minutes)	15
	I-AVG WINDOW (note n.2)	1...60 (minutes)	08

BASIC SETTINGS

WIRING	3P4W
QUADRANTS	2Q
CT PRIMARY	00005
CT SECONDARY	5
VT PRIMARY	000001
VT SECONDARY	001
P-AVG WINDOW	15
I-AVG WINDOW	08

COMUNICATION

ADDRESS	1 ... 247	027
BAUDRATE	2400, 4800, 9600, 19200, 38400	38400
DATA BITS	7, 8	8
PARITY	N = none, E = even, O = odd	N
STOP BITS	1 o 2	2
SILENT TIME	0...1000 (ms) (steps of 10ms)	0100

COMUNICATION

ADDRESS	027
BAUDRATE	38400
DATA BITS	8
PARITY	N
STOP BITS	2
SILENT TIME	0100

ALARM 1 (note n.7)

MODE (note n.3)	NORMAL, UNBAL%, UNBAL, 3-OF-3, 1-OF-3	NORMAL
DIRECTION (note n.4)	MAX, MIN	MIN
DATA ADDRESS (note n.5)	Controlled measure. See table n.1 for register selection	276
THRESHOLD (note n.5)	Threshold value	+0.000
HYSTERESIS	1...99 (%)	01
ON DELAY	1 sec ...99 minutes	01 SEC
OFF DELAY	1 sec ...99 minutes	01 SEC
OUT MODE (note n.6)	NORMAL, HOLD	NORMAL

ALARM 1

MODE	NORMAL
DIRECTION	MIN
DATA ADDRESS	276
THRESHOLD	+0.000
HYSTERESIS	01
ON DELAY	01 SEC
OFF DELAY	01 SEC
OUT MODE	NORMAL

ALARM 2 (see ALARM 1)

ALARM 3 (see ALARM 1)

ALARM 4 (see ALARM 1)

S0-1			
ENERGY (note n.9)	EA, ER L, ER C, ES, EA+, ER L+, ER C+, ES+, EA-, ER L-, ER C-, ES-	EA	
PRIMARY (note n.10)	NO, YES	NO	
WEIGHT	0.01 ... 9.99 (K,M)	+0.10	
WIDTH	10 ... 1000 ms	0030	

S0 - 1

ENERGY	Ea
PRIMARY	NO
WEIGHT	+0.10
WIDTH	0030

OPTICAL TEST (note n.8)

LED-1	OFF, S0-1, S0-2, S0-3, S0-4	S0-1
-------	-----------------------------	------

OPTICAL TEST

LED-1	S0-1
-------	------

DISPLAY

CONTRAST	0 ... 15	06
PASSWORD		0000
LIGHT HIGH	1 ... 15	10
LIGHT LOW	0 ... 15	03

DISPLAY

CONTRAST	06
PASSWORD	0000
LIGHT HIGH	10
LIGHT LOW	03

FACTORY RESET

	NO, YES	NO
--	---------	----

CLEAR REGISTERS

COUNTER-PHASE	NONE, ALL	NONE
MD POWER	NONE, ALL	NONE
MD CURRENT	NONE, ALL	NONE
PEAKS	NONE, ALL	NONE
COUNTER-MAIN	NONE, ALL	NONE
COUNTER-P1	NONE, ALL	NONE
COUNTER-P2	NONE, ALL	NONE
COUNTER-P3	NONE, ALL	NONE

CLEAR REGISTERS

COUNTER-PHASE	NONE
MD POWER	NONE
MD CURRENT	NONE
PEAKS	NONE
COUNTER-MAIN	NONE
COUNTER-P1	NONE
COUNTER-P2	NONE
COUNTER-P3	NONE

TABLE n.1 - Part of ModBus Registers; for e.g. alarm configuration. (Contact us for the full list).

REGISTER	DESCRIPTION	SYMBOL	UNIT
218	Frequency of U1N	f	[Hz]
220	Phase to Neutral Voltage, RMS Amplitude	U1N	[V]
222	Phase to Neutral Voltage, RMS Amplitude	U2N	[V]
224	Phase to Neutral Voltage, RMS Amplitude	U3N	[V]
226	Phase to Phase Voltage, RMS Amplitude	U12	[V]
228	Phase to Phase Voltage, RMS Amplitude	U23	[V]
230	Phase to Phase Voltage, RMS Amplitude	U31	[V]
232	Phase Current, RMS Amplitude	I1	[A]
234	Phase Current, RMS Amplitude	I2	[A]
236	Phase Current, RMS Amplitude	I3	[A]
238	Neutral Current, RMS Amplitude	IN	[A]
240	Phase Active Power (Imp/ Exp)	P1	[W]
242	Phase Active Power (Imp/ Exp)	P2	[W]
244	Phase Active Power (Imp/ Exp)	P3	[W]
246	Phase Reactive Power (Imp/ Exp)	Q1	[var]
248	Phase Reactive Power (Imp/ Exp)	Q2	[var]
250	Phase Reactive Power (Imp/ Exp)	Q3	[var]
252	Phase Apparent Power	S1	[VA]
254	Phase Apparent Power	S2	[VA]
256	Phase Apparent Power	S3	[VA]
258	Phase Power Factor (Imp/ Exp)	PF1	[-]
260	Phase Power Factor (Imp/ Exp)	PF2	[-]
262	Phase Power Factor (Imp/ Exp)	PF3	[-]
270	Phase to Neutral Voltage, Mean RMS Amplitude	UI	[V]
272	Phase to Phase Voltage, Mean RMS Amplitude	UD	[V]
274	Three phase current, RMS Amplitude	I	[A]
276	Total active power (Imp/ Exp)	PS	[W]
278	Total reactive power (Imp/ Exp)	QS	[var]
280	Total apparent power	SS	[VA]
282	Total power factor (Imp/ Exp)	PFS	[-]
332	Phase Current, RMS Amplitude, AVG	I1 AVG	[A]
334	Phase Current, RMS Amplitude, AVG	I2 AVG	[A]
336	Phase Current, RMS Amplitude, AVG	I3 AVG	[A]
344	Total imported active power, AVG	P Imp AVG	[W]
346	Total imported inductive power, AVG	Qind Imp AVG	[var]
348	Total imported capacitive power, AVG	Qcap Imp AVG	[var]
350	Total imported apparent power, AVG	S Imp AVG	[VA]
352	Total exported active power, AVG	P Exp AVG	[W]
354	Total exported inductive power, AVG	Qind Exp AVG	[var]
356	Total exported capacitive power, AVG	Qcap Exp AVG	[var]
358	Total exported apparent power, AVG	S Exp AVG	[VA]

NOTE n.1			
3P4W	3 phases	4 wires	Star
2P2W	2 phases	2 wires	Two-phases
1P2W	1 phases	2 wires	Single phase
3I	3 phases	2 wires	3 Current Inputs single phase or three phases
3P3W-B-3U	1 phases	3 wires	Balanced triangle
3P4W-B-3U	1 phases	4 wires	Balanced star
3P3W-B	1 phases	2 wires	Balanced triangle
3P4W-B	1 phases	2 wires	Balanced star
3P3W	2 phases	3 wires	Triangle
NOTE n.2			
POWERS	Integration time of the average value (AVG) and peak value (MD) for Power (from 1 to 60 minutes).		
CURRENTS	Integration time of the average value (AVG) and peak value (MD) for Current (from 1 to 60 minutes).		
NOTE n.3			
NORMAL	Classic Alarm with reference to a fixed threshold or to maximum and minimum delay and applicable hysteresis. "AVG" parameter is not used.		
UNBAL%	Considers also the 2 following registers of the selected one in "MEAS". "THRE" parameter becomes a % value. Alarm goes on when one of the three register is different from the percentage set on "THRE" comply with the higher value of the three read register if "MAX" is set on "TYPE", or comply with the lower value of the three register if "MIN" is set on "TYPE" With delay and applicable hysteresis.		
UNBAL	Considers also the 2 following registers of the selected one in "MEAS". "THRE" parameter becomes a value. Alarm goes on when one of the three register is different from the percentage set on "THRE" comply with the higher value of the three read register if "MAX" is set on "TYPE", or comply with the lower value of the three register if "MIN" is set on "TYPE" With delay and applicable hysteresis.		
3-OF-3	Considers also the 2 following registers of the selected one in "MEAS". It operates on a fixed max or min threshold with delay and applicable hysteresis. When all the three registers exceed the threshold the alarm goes ON. "AVG" parameter is not used.		
1-OF-3	Considers also the 2 following registers of the selected one in "MEAS". It operates on a fixed max or min threshold with delay and applicable hysteresis. If one of the three registers exceeds the threshold the alarm goes ON. "AVG" parameter is not used.		
NOTE n.4			
MAX	Alarm setting in excess or in decrease compared with the predefined conditions.		
MIN	With the exception of "UNBAL and UNBAL%".		
NOTE n.5			
MEAS	Indicates which register (measure) the alarm is related to. See table N.1 Input Register.		
THRE	Alarm threshold in absolute value, with the exception made for "UNBAL" in which the value inserted becomes a percentage.		
NOTE n.6			
NORMAL	Alarm remains active during the duration of the event. It restores automatically.		
HOLD	Alarm remains active until the manual reset via Modbus.		
NOTE n.7			
ALARM 1	MODBUS alarm (Associated with output 1 if present)		
ALARM 2	MODBUS alarm (Associated with output 2 if present)		
ALARM 3	MODBUS alarm (Associated with output 3 if present)		
ALARM 4	MODBUS alarm (Associated with output 4 if present)		
NOTE n.8			
LED-1	OFF	The instrument's LED remains off	
	S0-1, 2, 3, 4	The instrument's LED flashes according to the selected pulse generator	
NOTE n.9			
EA	Power (Energy) Active Imported / Exported		
ER L	Power (Energy) Reactive Inductive Imported / Exported		
ER C	Power (Energy) Reactive Capacitive Imported / Exported		
ES	Power (Energy) Apparent Imported / Exported		
EA+	Power (Energy) Active Imported		
ER L+	Power (Energy) Imported Inductive Reactive		
ER C+	Power (Energy) Imported Reactive Capacitive		
ES+	Power (Energy) Apparent Imported		
EA-	Power (Energy) Active Exported		
ER L-	Power (Energy) Exported Inductive Reactive		
ER C-	Power (Energy) Capacitive Reactive		
ES-	Power (Energy) Apparent Exported		
NOTE n.10			
YES	Referred to the primary of the current transformer (CT)		
NO	Referred to the secondary of the current transformer (CT)		

INPUTS - OUTPUTS

INPUTS			OUTPUTS		
10	C2	Common2 (negative)	19	C1	Common1 (negative)
11	I2	Input 2 (positive)	20	O1	Output 1 (positive)
12	C1	Common1 (negative)	21	C2	Common2 (negative)
13	I1	Input 1 (positive)	22	O2	Output 2 (positive)

INPUTS		OUTPUTS	
Supply voltage (external):	from 10 to 30 Vdc	Maximum applicable voltage:	27 Vdc
Current consumption:	from 2 to 10mA	Maximum switchable current:	27mA
Max. count frequency	10 or 100Hz		
N.B. For gas meters a galvanic separation is needed per ATEX standards		N.B. Transistor optocoupler digital outputs (NPN) according to DIN 43864.	

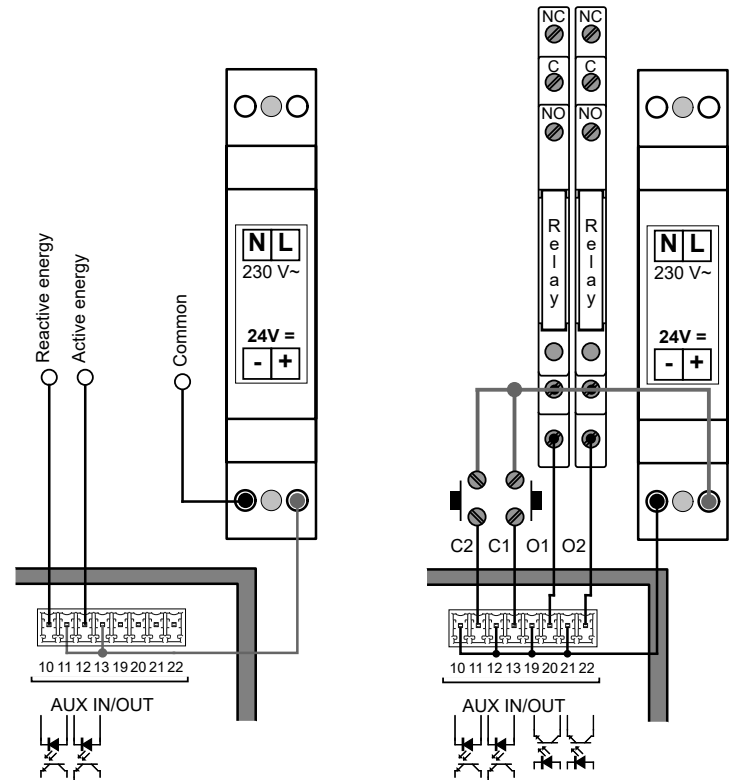

ALARM SETUP EXAMPLE

Alarm (latching) when the average active power (MEAS 344) exceeds the value of 100 kW, hysteresis of 5% and delay of 5 seconds; set the parameters as in the table:

ALARM 1 (note n.7)			
MODE (note n.3)	NORMAL, UNBAL%, UNBAL, 3-OF-3, 1-OF-3		NORMAL
DIRECTION (note n.4)	MAX, MIN		MAX
DATA ADDRESS (note n.5)	Controlled measure. See table n.1 for register selection		344
THRESHOLD (note n.5)	Threshold value		+100.0 K
HYSTERESIS	1...99 (%)		05
ON DELAY	1 sec...99 minutes		05 SEC
OFF DELAY	1 sec...99 minutes		01 SEC
OUT MODE (note n.6)	NORMAL, HOLD		NORMAL

VOLTAGE CONNECTION

Use cables with max cross-section of 2,5 mm² if stranded, 4 mm² if rigid and connect them to the clamps marked VOLTAGE INPUT on the instrument according to the applicable diagrams that follow.

1P2W

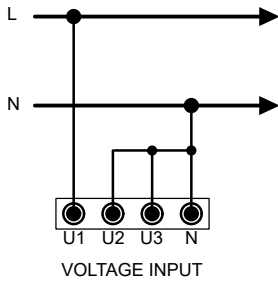

3I

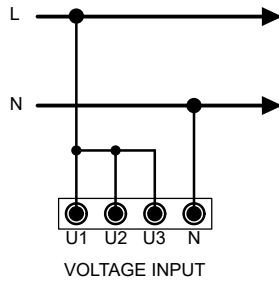

3P4W / 3P4W-B-3U / 3I

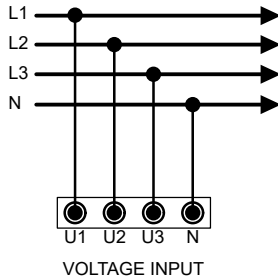

3P4W-B

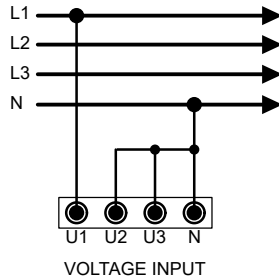

3P3W / 3P3W-B-3U

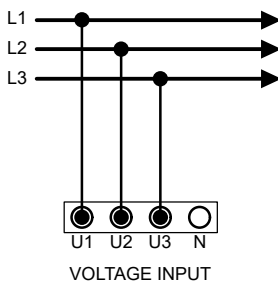

2P2W / 3P3W-B

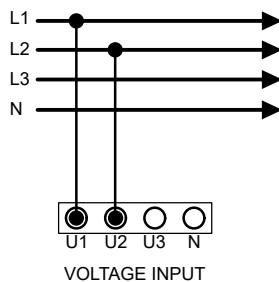

PHASE SEQUENCE

1-2-3	Correct sequence
1-3-2	Incorrect sequence
----	Indicates that the device is not able to define the sequence

Please consider that:

- only the voltage sequence is detected;
- the detection considers the hypothesis that the tensions are sinusoidal (or at least slightly distorted) and belonging to a symmetrical (or almost) triad;
- independently from the insertion 3W/4W, it is considered exclusively the sign of voltage 2 and 3 in the zero-crossing of voltage for phase 1 - it is not calculated the effective phase of the voltage fundamentals;
- the phase sequence is indicated with the "L123", "L132", "L—" symbols next to frequency, in the voltages displaying page.

It is assumed:

- L1 is the voltage with phase 0°
- L2 is the voltage with phase 240° (in delay to L1)
- L3 is the voltage with phase 120° (in advance to L1)

CURRENT CONNECTION

Connect the CT outputs to the terminals marked I1, I2, I3 (CURRENT INPUT) of the instrument according to the applicable diagrams that follow.

1P2W / 2P2W

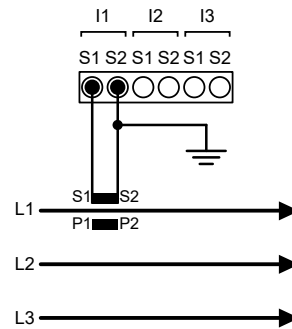

3P3W

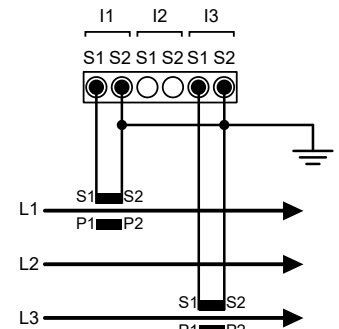

3P4W-B / 3P4W-B-3U

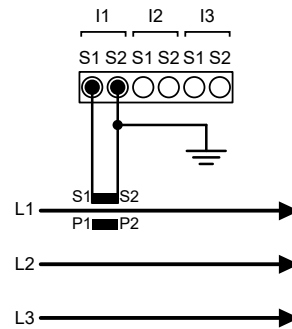

3P3W / 3P4W / 3I

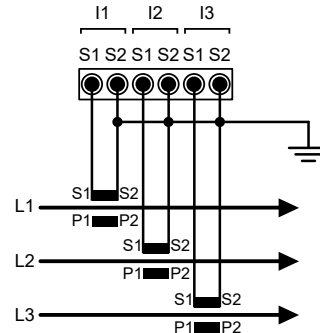

3P3W-B / 3P3W-B-3U

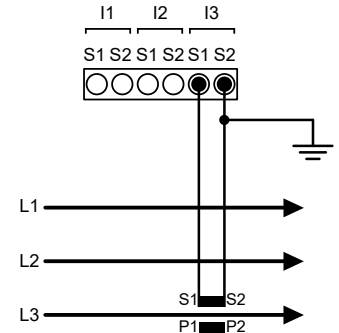

Note: Scrupulously respect the matching of phase between the voltage signals and current signals. Failure to comply with this correspondence and connection diagrams gives rise to measurement errors.

POWER SUPPLY

The instrument is equipped with a separate power supply. The power supply terminals are numbered (17) and (18). Use cables with max cross-section of 2,5 mm² if stranded, 4 mm² if rigid.

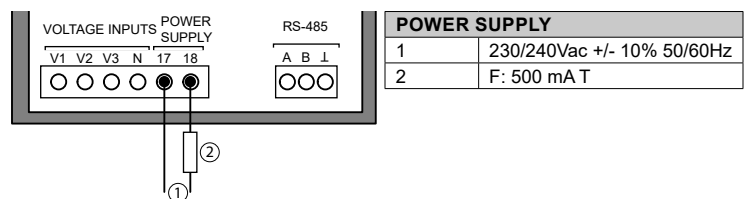

POWER SUPPLY	
1	230/240Vac +/- 10% 50/60Hz
2	F: 500 mA T

SERIAL LINE CONNECTION

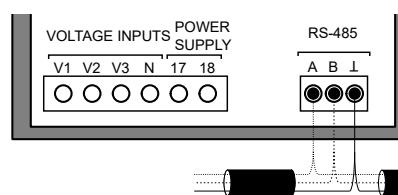

RS485	
Address	27
Baud rate	38400
Parity	None
Bit of Stop	2

Max cable length: 1000 meters.