

ATTO D4 DC 3I 230-240Vac

INSTALLATION INSTRUCTIONS

COPYRIGHT

Electrex is a trademark of Akse S.r.l. All rights reserved.

It is forbidden to duplicate, adapt, transcript this document without Akse written authorization, except when regulated accordingly by the Copyright Laws.

WARRANTY

This product is covered by a warranty against material and manufacturing defects for a period of 24 months period from the manufacturing date.

The warranty does not cover the defects that are due to:

- Negligent and improper use
- Failures caused by atmospheric hazards
- Acts of vandalism
- Wear out of materials
- Firmware upgrades

Akse reserves the right, at its discretion, to repair or substitute the faulty products

The warranty is not applicable to the products that will result defective in consequence of a negligent and improper use or an operating procedure not contemplated in this manual.

RETURN AND REPAIR FORMALITIES

Akse accepts the return of instruments for repair only when authorized in advance. The transport costs are at customer charge.

RE-SHIPING OF REPAIRED PRODUCT

The terms for re-shipment of repaired products are ex-works, i.e. the transport costs are at customer charge.

Products returned as defective but found to be perfectly working by our laboratories, will be charged a flat fee to account for checking and testing time irrespective of the warranty terms.

SAFETY

This instrument was manufactured and tested in compliance with IEC 61010 CAT III-300V, class 2 standards for operating voltages up to 300 VAC rms phase to neutral.

In order to maintain this condition and to ensure safe operation, the user must comply with the indications and markings contained in the following instructions:

- When the instrument is received, before starting its installation, check that it is intact and no damage occurred during transport.
- Before mounting, ensure that the instrument operating voltages and the mains voltage are compatible then proceed with the installation.
- The instrument power supply needs no earth connection.
- The instrument is not equipped with a power supply fuse; a suitable external protection fuse must be foreseen by the contractor.
- Maintenance and/or repair must be carried out only by qualified, authorized personnel
- If there is ever the suspicion that safe operation is no longer possible, the instrument must be taken out of service and precautions taken against its accidental use.
- Operation is no longer safe when:

- 1) There is clearly visible damage.
- 2) The instrument no longer functions.
- 3) After lengthy storage in unfavorable conditions.
- 4) After serious damage occurred during transport

The instruments must be installed in respect of all the local regulations.

OPERATOR SAFETY

Warning: Failure to observe the following instructions may lead to a serious danger of death.

- During normal operation dangerous voltages can occur on instrument terminals and on voltage and current transformers. Energized voltage and current transformers may generate lethal voltages. Follow carefully the standard safety precautions while carrying out any installation or service operation.
- The terminals of the instrument must not be accessible by the user after the installation. The user should only be allowed to access the instrument front panel where the display is located.
- Do not use the digital outputs for protection functions nor for power limitation functions. The instrument is suitable only for secondary protection functions.
- The instrument must be protected by a breaking device capable of interrupting both the power supply and the measurement terminals. It must be easily reachable by the operator and well identified as instrument cut-off device.
- The instrument and its connections must be carefully protected against short-circuit.

Precautions: Failure to respect the following instructions may irreversibly damage to the instrument.

- The instrument is equipped with PTC current limiting device but a suitable external protection fuse should be foreseen by the contractor.
- The outputs and the options operate at low voltage level; they cannot be powered by any unspecified external voltage.
- The application of currents not compatible with the current inputs levels will damage to the instrument.

Further documentation may be downloaded from our web site www.electrex.it.

This document is owned by company AKSE that reserves all rights.

DECLARATION OF CONFORMITY

Akse hereby declares that its range of products complies with the following directives EMC 89/336/EEC 73/23CE 93/68 CE and complies with the following product's standard CEI EN 61326 – IEC 61326 CEI EN 61010 – IEC 1010.

The product has been tested in the typical wiring configuration and with peripherals conforming to the EMC directive and the LV directive.

The instrument is programmed with the following default values:

| PAGE | MENU DISPLAYED | AVAILABLE PARAMETERS | DEFAULT |
|---------------------------------|---------------------|---|---------|
| PASSWORD REQUESTED | | 0000 ... 9999 | 0000 |
| RS485 | | | |
| | RS 485 ADDRESS | 1 ... 247 | 27 |
| | Comm. Speed | 2400, 4800, 9600, 19200, 38400 | 38400 |
| | Data Bit | 7 o 8 | 8 |
| | Parity | N = no parity, E = peer parity, O = odd parity | N |
| | Bit of stop | 1 o 2 | 2 |
| NETWORK | | | |
| | Export | NO, YES | NO |
| | I FS | 1 ... 10000 | 00010 |
| | SHUNT | 60 o 100 | 60 |
| | VR | 400000/999 | 1/1 |
| AVG-MD TIME (note n.2) | | | |
| | POWERS | 1...60 (minutes) | 15 |
| | CURRENTS | 1...60 (minutes) | 8 |
| ALARM 1 / A (note n.11) | | | |
| | MODE (note n.3) | Normal, DERIV | NORMAL |
| | TYPE (note n.4) | MAX, MIN | MIN |
| | MEAS (note n.5) | Controlled measure. See table n.1 for register selection. | 200 |
| | THRE (note n.5) | Valore soglia | 0 |
| ALARM 1 / B | | | |
| | HYST | 1...100 (%) | 1 |
| | DELAY | 1...99 (seconds) | 1 |
| | AVG (note n.6) | 1...99 (seconds) | 1 |
| | OUT (note n.7) | Normal, Hold, Pulse-L, Pulse-S | NORMAL |
| ALARM 2 / A (note n.11) | | | |
| | MODE (note n.3) | Normal, DERIV | NORMAL |
| | TYPE (note n.4) | MAX, MIN | MIN |
| | MEAS (note n.5) | Controlled measure. See table n.1 for register selection. | 200 |
| | THRE (note n.5) | Valore soglia | 0 |
| ALARM 2 / B | | | |
| | HYST | 1...100 (%) | 1 |
| | DELAY | 1...99 (seconds) | 1 |
| | AVG (note n.6) | 1...99 (seconds) | 1 |
| | OUT (note n.7) | Normal, Hold, Pulse-L, Pulse-S | NORMAL |
| ALARM 3 / A (note n.11) | | | |
| | MODE (note n.3) | Normal, DERIV | NORMAL |
| | TYPE (note n.4) | MAX, MIN | MIN |
| | MEAS (note n.5) | Controlled measure. See table n.1 for register selection. | 200 |
| | THRE (note n.5) | Valore soglia | 0 |
| ALARM 3 / B | | | |
| | HYST | 1...100 (%) | 1 |
| | DELAY | 1...99 (seconds) | 1 |
| | AVG (note n.6) | 1...99 (seconds) | 1 |
| | OUT (note n.7) | Normal, Hold, Pulse-L, Pulse-S | NORMAL |
| ALARM 4 / A (note n.11) | | | |
| | MODE (note n.3) | Normal, DERIV | NORMAL |
| | TYPE (note n.4) | MAX, MIN | MIN |
| | MEAS (note n.5) | Controlled measure. See table n.1 for register selection. | 200 |
| | THRE (note n.5) | Valore soglia | 0 |
| ALARM 4 / B | | | |
| | HYST | 1...100 (%) | 1 |
| | DELAY | 1...99 (seconds) | 1 |
| | AVG (note n.6) | 1...99 (seconds) | 1 |
| | OUT (note n.7) | Normal, Hold, Pulse-L, Pulse-S | NORMAL |
| DIGITAL OUT 1 (note n.8) | | | |
| | MODE | PULSE, ALARM, REMOTE | PULSE |
| | POLARITY | NO, NC | NO |
| PULSE OUT 1 | | | |
| | MEAS (note n.9) | P-IMP, P-EXP | P-IMP |
| | PRIMARY (note n.10) | YES, NO | YES |
| | WEIGHT | 1...100000000 (Wh/100) | 100000 |
| | WIDTH | 50ms...1S | 500 |
| DIGITAL OUT 2 (note n.8) | | | |
| | MODE | PULSE, ALARM, REMOTE | PULSE |
| | POLARITY | NO, NC | NO |
| PULSE OUT 2 | | | |
| | MEAS (note n.9) | P-IMP, P-EXP | P-EXP |
| | PRIMARY (note n.10) | YES, NO | YES |
| | WEIGHT | 1...100000000 (Wh/100) | 100000 |
| | WIDTH | 50ms...1S | 500 |

| MECHANICAL CHARACTERISTICS | |
|----------------------------|---|
| Enclosure | Self-extinguishing plastic material class V0 |
| Protection degree | IP40 on front panel |
| Dimensions | 70 x 90 x 58 mm (4 DIN modules) |
| VOLTAGE INPUT | |
| Direct | Fino a 300 V |
| | max 360 V |
| Power supply | 230/240Vac +/- 10% 50/60Hz |
| Self consumption | < 3VA |
| MODELS | |
| PFA7481-E2 | ATTO D4 DC 3I RS485 230-240V 1DI 2DO SELF POWERED TRAN. / ANALYZER |

| Holding Registers | | | | |
|-------------------|-------------|------|---|---|
| Address | n° Register | Type | Description | Value |
| 100 | 2 | I | Primary VT | from 1 to 400000 V |
| 102 | 1 | I | Secondary VT | from 1 to 999 V |
| 103 | 1 | I | Primary CT (Not used if version 70A) | from 1 to 10000 A |
| 104 | 1 | I | Secondary CT (Current full scale if version 70A) | 1 or 5 A (14 or 70 if version 70A with external CT. In this version, registers 103 and 104 point to the same parameter.) |
| 105 | 1 | B | Insertion mode | Bit 7 = Enables Export Bit 0-3 = Insertion modality: 0x00 // 0 = 1P, 0x01 // 1 = 2P 0x02 // 2 = 3P_4W, 0x03 // 3 = 3P_3W_2CT |
| 106 | 1 | I | Integration Time for Power | from 1 to 60 min |
| 107 | 1 | I | Integration Time for Current | from 1 to 60 min |
| 109 | 1 | B | Life Timer 2 (partial) | Bit 0-1 = Command input selection (0-4, 0=disables external command) Bit 4 = Command from alarm channel (0=command from digital input, 1=command from alarm) Bit 7 = inverts command polarity (0= counts if command is active, 1=counts if command is not active) |
| 110 | 1 | B | Energy Counters set 1 (totals) | Bit 0-1 = Command input selection Bit 4 = Command from alarm channel Bit 7 = inverts command polarity |
| 111 | 1 | B | Energy Counters set 2 (partials) | Bit 0-1 = Command input selection Bit 4 = Command from alarm channel Bit 7 = inverts command polarity |
| 128 | 1 | I | Total counters set symbol | 2 ASCII characters from 0x30 to 0x39 and from 0x41 to 0x5A |
| 129 | 1 | I | Partial counters set symbol | 2 ASCII characters from 0x30 to 0x39 and from 0x41 to 0x5A |
| 135 | 1 | I | Pulse output 1 measure selection | Bit 0-2 = Power index (0=Pimp, 1=QindImp, 2=QcapImp, 3=Simp, 4=Pexp, 5=QindExp, 6=QcapExp, 7=Sexp) Bit 7 = Value to secondary CT/VT e.g.: 0x00, 0x01, 0x02...=primary; 0x80, 0x81, 0x82...=secondary |
| 136 | 1 | I | Pulse length output 1 | from 50 to 1000 ms |
| 137 | 2 | I | Pulse weight output 1 | in Wh/100, from 1 to 100000000 |
| 139 | 1 | I | Pulse output 2 measure selection | Bit 0-2 = Power Index Bit 7 = Secondary |
| 140 | 1 | I | Pulse length output 2 | from 50 to 1000 ms |
| 141 | 2 | I | Pulse weight output 2 | in Wh/100, from 1 to 100000000 |
| 155 | 1 | B | Configuration DO1 | Bit 0-1 = Mode (0=modbus command, 1=alarm, 2=pulses) Bit 7 = Normally closed |
| 156 | 1 | B | Configuration DO 1 | Bit 0-1 = Mode (0=modbus command, 1=alarm, 2=pulses) Bit 7 = Normally closed |
| 159 | 1 | I | Measure selection alarm 1 | IR address to which connect the alarm. From 200 to 390 |
| 160 | 1 | I | Alarm 1 Mode | Bit 0-3 = Alarm Mode 0 = Normal 1 = 1/3 (takes the measure from the next two addr. from the one programmed) 2 = 3/3 (takes the measure from the next two addr. from the one programmed) 3 = Imbalance (takes the measure from the next two addr. from the one programmed) 4 = Variation (delta) compared to the average value in floating window. Bit 4 = Direction (polarity): 0 = Min (negative if derived) 1 = Max (positive if derived) Bit 8-11 = Pilotage mode output 0 = Normal 1 = Short pulse (100mS) - No effect on IR/HR (as mode 0) 2 = Long pulse (500mS) - No effect on IR/HR (as mode 0) 3 = Hold Bit 12-14 = Output logic selection Bit 12 = Output port operator 0 out = A or B 1 out = A and B Bit 13 = Operator port A (0=OR, 1=AND) Bit 14 = Operator port B (0=OR, 1=AND) |
| 161 | 1 | I | Logic combination alarm 1 | Bit 0-3 = Alarm channels input port A Bit 4-7 = Digital inputs - input port A Bit 8-11 = Alarm channels input port B Bit 12-15 = Digital inputs - input port B |
| 162 | 1 | I | Integration time alarm 1 | If Mode=Variation: Amplitude of the integration interval for average calculation (from 1 to 99 sec) |
| 163 | 1 | I | Alarm 1 hysteresis | 0-99 % |
| 164 | 1 | I | Alarm 1 delay | 0-99 s (bit 0-7=activation delay, bit 8-15=deactivation delay?) |
| 165 | 2 | F | Alarm 1 threshold | In percentage if Mode=Imbalance or Mode=Variation. Is automatically rounded to the number of digits editable keyboard. |
| 167 | 1 | I | Measure selection alarm 2 | |
| 168 | 1 | I | Mode alarm 2 | |
| 169 | 1 | I | Logic combination alarm 2 | |
| 170 | 1 | I | Integration time alarm 2 | |
| 171 | 1 | I | Alarm 2 hysteresis | |
| 172 | 1 | I | Alarm 2 delay | |
| 173 | 2 | F | Alarm 2 threshold | |
| 215 | 1 | I | Serial transmission delay | da 10 a 1000 ms |
| 216 | 1 | B | Serial port: swap flags | Top Byte always equal to Bottom Byte. 0x01 Swap bytes 0x02 Swap word 0x04 Swap dwords 0x08 Swap words in floats 0x10 Swap bytes in floats 0x80 BCD Mode (not yet!) |
| 217 | 1 | I | Serial port: comm. speed | 0=2400, 1=4800, 2=9600, 3=19200, 4=38400 |
| 221 | 1 | B | Output command | Bit 0 = Output 1, Bit 1 = Output 2 Bit 2 = Output 3, Bit 3 = Output 4 |
| 223 | 1 | B | Combined Alarm Status | Bit 0 = Channel 1, Bit 1 = Channel 2 Bit 2 = Channel 3, Bit 3 = Channel 4 |
| 226 | 1 | I | Instrument Reset | The writing of the word "0xDEAD" causes the reboot |

| | | | | |
|-----|---|---|---------------------------------|--|
| 230 | 1 | B | Reset counters set 1 (totals) | Bit 0 = Ea, Bit 1 = Er ind, Bit 2 = Er cap, Bit 3 = Es (imp) Bit 4 = Ea, Bit 5 = Er ind, Bit 6 = Er cap, Bit 7 = Es (exp) |
| 231 | 1 | B | Reset counters set 2 (partials) | Bit 0 = Ea, Bit 1 = Er ind, Bit 2 = Er cap, Bit 3 = Es (imp) Bit 4 = Ea, Bit 5 = Er ind, Bit 6 = Er cap, Bit 7 = Es (exp) |
| 232 | 1 | B | Reset counters phase 1 | Bit 0 = Ea, Bit 1 = Er ind, Bit 2 = Er cap, Bit 3 = Es (imp) Bit 4 = Ea, Bit 5 = Er ind, Bit 6 = Er cap, Bit 7 = Es (exp) |
| 233 | 1 | B | Reset counters phase 2 | Bit 0 = Ea, Bit 1 = Er ind, Bit 2 = Er cap, Bit 3 = Es (imp) Bit 4 = Ea, Bit 5 = Er ind, Bit 6 = Er cap, Bit 7 = Es (exp) |
| 234 | 1 | B | Reset counters phase 3 | Bit 0 = Ea, Bit 1 = Er ind, Bit 2 = Er cap, Bit 3 = Es (imp) Bit 4 = Ea, Bit 5 = Er ind, Bit 6 = Er cap, Bit 7 = Es (exp) |
| 235 | 1 | B | Reset AVG powers | Bit 0 = P, Bit 1 = Q ind, Bit 2 = Q cap, Bit 3 = S (imp) Bit 4 = P, Bit 5 = Q ind, Bit 6 = Q cap, Bit 7 = S (exp) |
| 236 | 1 | B | Reset MD powers | Bit 0 = P, Bit 1 = Q ind, Bit 2 = Q cap, Bit 3 = S (imp) Bit 4 = P, Bit 5 = Q ind, Bit 6 = Q cap, Bit 7 = S (exp) |
| 237 | 1 | B | Reset AVG currents | Bit 0 = I1, Bit 1 = I2, Bit 2 = I3 |
| 238 | 1 | B | Reset MD currents | Bit 0 = I1, Bit 1 = I2, Bit 2 = I3 |
| 239 | 1 | B | Reset min/max Us | Bit 0 = max U1, Bit 1 = max U2, Bit 2 = max U3, Bit 3 = x Bit 4 = min U1, Bit 5 = min U2, Bit 6 = min U3 |
| 240 | 1 | B | Reset min/max Ud | Bit 0 = max U1, Bit 1 = max U2, Bit 2 = max U3, Bit 3 = x Bit 4 = min U1, Bit 5 = min U2, Bit 6 = min U3 |
| 241 | 1 | B | Reset min/max I | Bit 0 = max I1, Bit 1 = max I2, Bit 2 = max I3, Bit 3 = max In |
| 242 | 1 | B | Reset min/max Pimp | Bit 0 = max P1, Bit 1 = max P2, Bit 2 = max P3 |
| 243 | 1 | B | Reset min/max Pexp | Bit 0 = max P1, Bit 1 = max P2, Bit 2 = max P3 |

| | |
|---|---------------|
| F | Float IEEE754 |
| I | Integer |
| B | Bitmapped |

| INPUT REGISTERS | | | | | |
|-----------------|-------------|------|---|---------|----------|
| Address | n° Register | Type | Description | Symbol | Unit |
| 220 | 2 | F | Phase to Neutral Voltage, RMS Amplitude | U1N | [V] |
| 232 | 2 | F | Phase Current, RMS Amplitude | I1 | [A] |
| 240 | 2 | F | Phase Active Power (+/-) | P1 | [W] |
| 284 | 2 | F | Internal Temperature, °C | T | [°C] |
| 286 | 2 | F | Internal Temperature, °F | T | [°F] |
| 288 | 2 | F | Phase to Neutral Voltage, RMS Amplitude, MIN | U1N MIN | [A] |
| 294 | 2 | F | Phase to Neutral Voltage, RMS Amplitude, MAX | U1N MAX | [A] |
| 312 | 2 | F | Phase Current, RMS Amplitude, MAX | I1 MAX | [A] |
| 320 | 2 | F | Phase Active Power, Import, MAX | P1+ MAX | [A] |
| 326 | 2 | F | Phase Active Power, Export, MAX | P1- MAX | [A] |
| 332 | 2 | F | Phase Current, RMS Amplitude, AVG | I1 AVG | [A] |
| 338 | 2 | F | Phase Current, RMS Amplitude, MD | I1 MD | [A] |
| 344 | 2 | F | Total imported active power, AVG | P+ AVG | [W] |
| 352 | 2 | F | Total exported active power, AVG | P- AVG | [W] |
| 360 | 2 | F | Total imported active power, MD | P+ MD | [W] |
| 368 | 2 | F | Total exported active power, MD | P- MD | [W] |
| 376 | 2 | F | External Pulse Counter, With Weight, Total counter or Tariff T1 | CNT1 S | |
| 384 | 2 | F | External Pulse Counter, With Weight, Partial Counter or Tariff T2 | CNT1 P | |
| 392 | 2 | I | External Pulse Counter, Total counter or Tariff T1 | CNT1 S | [-] |
| 400 | 2 | I | Lifetimer, Total counter | TIME S | [s] |
| 402 | 2 | I | External Pulse Counter, Partial Counter or Tariff T2 | CNT1 P | [-] |
| 410 | 2 | I | Lifetimer, Partial Counter or Conditional Counter | TIME P | [s] |
| 428 | 2 | I | Total imported active energy, Partial Counter or Tariff T2 | Ea P + | [kWh/10] |
| 436 | 2 | I | Total exported active energy, Partial Counter or Tariff T2 | Ea P - | [kWh/10] |
| 492 | 1 | B | Digital Inputs Status | DI | [-] |
| 494 | 1 | B | Alarms Status (simple) | ALS | [-] |
| 495 | 1 | B | Alarms Status (combined) | ALC | [-] |
| 528 | 4 | I | Total imported active energy, Partial Counter or Tariff T2 | Ea P + | [Wh/10] |
| 544 | 4 | I | Total exported active energy, Partial Counter or Tariff T2 | Ea P - | [Wh/10] |

| | |
|------------------|---|
| NOTE n.2 | |
| POWERS | Integration time of the average value (AVG) and max. value (MD) for power (from 1 to 60 minutes) |
| CURRENTS | Tempo di integrazione del valore medio (AVG) e di punta (MD) per la corrente (da 1 a 60 minuti) |
| NOTE n.3 | |
| NORMAL | Classic alarm with reference to a fixed or max / min threshold, with applicable hysteresis and delay. The "AVG" parameter is not used. |
| DERIV | The "THRE" parameter becomes a percentage value. The instantaneous value applied to the alarm on "MEAS" will be compared with its averaged value obtained depending on the time set on "AVG". When the instantaneous value combined to the alarm differs in "more then" (if set "MAX") or in "less then" (if set "MIN") compared to the average value ("AVG") of the percentage set on "THRE", the alarm triggers. With applicable hysteresis and delay. The "AVG" parameter is used. |
| NOTE n.4 | |
| MAX | Alarm configuration in "excess" according to the conditions set. Except the "UNBAL" mode. |
| MIN | Alarm configuration "decreasing" according to the conditions set. Except the "UNBAL" mode. |
| NOTE n.5 | |
| MEAS | Indicates on which register (and on which measure) the alarm is reported. See table n.1 (Input Register). |
| THRE | Alarm threshold in absolute value, except the "DERIV" value where the value inserted becomes a percentage. |
| NOTE n.6 | |
| AVG | Parameter to be used in the sole "DERIV" mode. Floating window amplitude (in seconds) used for creating a reference value to which compare the instantaneous value. |
| NOTE n.7 | |
| NORMAL | The output remains exited during all the alarm, after all it falls. |
| HOLD | The output remains exited until the manual reset made through Modbus |
| PULSE-L | The output generates a 500ms pulse on the alarm triggering. |
| PULSE-S | The output generates a 100ms pulse on the alarm triggering. |
| NOTE n.8 | |
| PULSE | Enables output function as impulsive |
| ALARM | Enables output function as alarm |
| REMOTE | Enables output function through Modbus Protocol |
| NO | Normally open |
| NC | Normally closed |
| NOTE n.9 | |
| P-IMP | Imported Active Power (Energy) |
| QL-IMP | Imported Inductive Reactive Power (Energy) |
| QC-IMP | Imported Capacitive Reactive Power (Energy) |
| S-IMP | Imported Apparent Power (Energy) |
| P-EXP | Exported Active Power (Energy) |
| QL-EXP | Exported Inductive Reactive Power (Energy) |
| QC-EXP | Exported Capacitive Reactive Power (Energy) |
| S-EXP | Exported Apparent Power (Energy) |
| NOTE n.10 | |
| YES | Referred to the primary of the CT |
| NO | Referred to the secondary of the CT |
| NOTE n.11 | |
| ALLARME 1 | Alarm associated to the physic output DIGITAL OUT 1 (DO1, terminal 8) |
| ALLARME 2 | Alarm associated to the physic output DIGITAL OUT 2 (DO2, terminal 9) |
| ALLARME 3 | MODBUS only alarm |
| ALLARME 4 | MODBUS only alarm |

ALARM SETTING EXAMPLES

In order that the output "DIGITAL OUT 1" gets excited and remains such during all the alarm (latching): when the Average Active Power (MEAS 344) exceeds the value of 100 kW, hysteresis 5% and delay of 5 seconds, set the parameters as in the table below:

| | | | |
|----------------------|-----------------|--|--------|
| ALARM 1 / A | MODE (note n.2) | Normal, DERIV | NORMAL |
| | TYPE (note n.3) | MAX, MIN | MAX |
| | MEAS (note n.4) | Controlled measure. See table n.1 for the register selection | 344 |
| | THRE (note n.4) | Threshold value | 100000 |
| ALARM 1 / B | HYST | 1...100 (%) | 5 |
| | DELAY | 1...99 (seconds) | 5 |
| | AVG (note n.5) | 1...99 (seconds) | 1 |
| | OUT (note n.6) | Normal, Hold, Pulse-L, Pulse-S | NORMAL |
| DIGITAL OUT 1 | MODE | PULSE, ALARM, REMOTE | ALARM |
| | POLARITY | NO, NC | NO |

In order that the output "DIGITAL OUT 1" gets excited and remains such during all the alarm (latching): when the Average Active Power (MEAS 344) falls below the value of 90 kW, hysteresis 5% and delay of 5 seconds, set the parameters as in the table below:

| | | | |
|----------------------|-----------------|--|--------|
| ALARM 2 / A | MODE (note n.2) | Normal, DERIV | NORMAL |
| | TYPE (note n.3) | MAX, MIN | MIN |
| | MEAS (note n.4) | Controlled measure. See table n.1 for the register selection | 344 |
| | THRE (note n.4) | Threshold value | 90000 |
| ALARM 2 / B | HYST | 1...100 (%) | 5 |
| | DELAY | 1...99 (seconds) | 5 |
| | AVG (note n.5) | 1...99 (seconds) | 1 |
| | OUT (note n.6) | Normal, Hold, Pulse-L, Pulse-S | NORMAL |
| DIGITAL OUT 2 | MODE | PULSE, ALARM, REMOTE | ALARM |
| | POLARITY | NO, NC | NO |

VOLTAGE AND CURRENT CONNECTION

Voltage connection:

Use cables with max cross-section of 2,5 mm² if stranded 4 mm² if rigid and connect them to the terminals marked VOLTAGE INPUT on the instrument according to the applicable diagrams that follow.

Current connection:

Use SHUNT with adequate primary and 60 or 100 mV as secondary rate. Connect the SHUNT to the terminals marked I1 (S1 e S2) (current input) according to the applicable diagrams that follow.

SHUNT CONNECTION

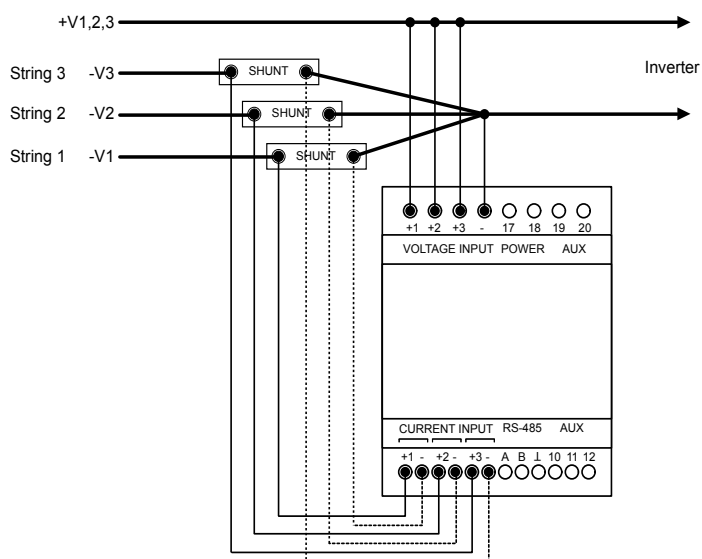

ATTENTION

The shunt's resistance has a range of mohm, here below you can find some resistance values related to different models of shunts.

| PRIMARY (A) | SECONDARY (mV) | RESISTANCE(mohm) |
|-------------|----------------|------------------|
| 5 | 60 | 12 |
| 10 | 60 | 6 |
| 25 | 60 | 2,4 |
| 100 | 100 | 1 |

The length of the connections and the serial insertion of protection devices (fuses, switchers, etc.), can distort the measurement results.

POWER SUPPLY AND SERIAL LINE CONNECTION

The instrument is fitted with a separate power supply. The power supply terminals are numbered (17) and (18). Use cables with max cross-section of 2,5 mm² if stranded, 4 mm² if rigid

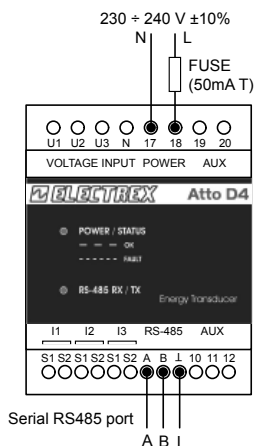

DIGITAL INPUT & OUTPUT CONNECTION

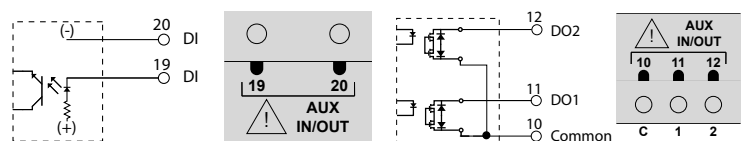

| Digital Inputs | |
|--|-------------|
| Max voltage (open circuit) | 15 Vdc |
| Max current (closed circuit) | 5 mA |
| Max. count frequency | 10 or 100Hz |
| N.B. For gas meters a galvanic separation is needed per ATEX standards | |

| Digital outputs optomox | |
|-----------------------------|-------------|
| Maximum applicable voltage: | 250 V ac/dc |
| Maximum switchable current: | 100 mA |

PRECAUTIONS FOR NOT ALTERING THE MEASUREMENTS

- The wire's length from the shunt's output terminal (1,2,3) to the junction point (4) must be the shortest possible (lower than 100cm);
- The wires should have the same length;

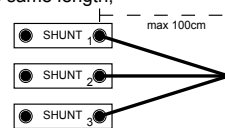

- The shunt and the instrument should be installed, preferably, within the same or in adjacent panels.

4) Important:

- Do not insert fuses in the shunt's output: the fuse has a resistance and it is not the same for all the fuses;
- Do not insert breakers in the shunt's output: the contact surface of the breaker generates a resistance;
- Do not insert diodes in the shunt's output;

The presence of fuses, breakers or diodes before the input of the shunt does not generate measurement distortion.

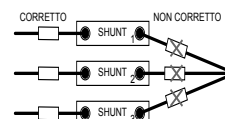

- Do not make any bridge connection on the shunt outputs. In the example here below the resistance between the points 1-4 and 3-4 results higher than the one between the points 2-4, because the bridge's resistances is added too.

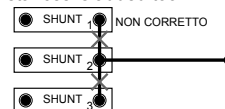

- The wire's length from the point (4) and the "-" input of the instrument must not be higher than 100cm.

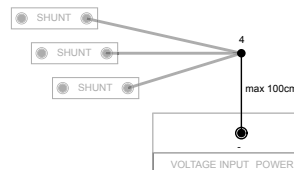

- The shunts must be connected on the negative pole.

EXAMPLE OF DIGITAL INPUT & OUTPUT CONNECTION

