

# FEMTO ECT RJ45 & NET D6

## INSTALLATION GUIDE

### COPYRIGHT

Electrex is a trademark of Akse S.r.l. All rights reserved.  
It is forbidden to duplicate, adapt, transcript this document without Akse written authorization, except when regulated accordingly by the Copyright Laws.

### WARRANTY

This product is covered by a warranty against material and manufacturing defects for a 24 months period from the manufacturing date.

The warranty does not cover the defects that are due to:

- Negligent and improper use
- Failures caused by atmospheric hazards
- Acts of vandalism
- Wear out of materials
- Firmware upgrades

Akse reserves the right, at its discretion, to repair or substitute the faulty products

The warranty is not applicable to the products that will result defective in consequence of a negligent and improper use or an operating procedure not contemplated in this manual.

### RETURN AND REPAIR FORMALITIES

Akse accepts the return of instruments for repair only when authorized in advance. The transport costs are at customer charge.

### RE-SHIPING OF REPAIRED PRODUCT

The terms for re-shipment of repaired products are ex-works, i.e. the transport costs are at customer charge.

Products returned as defective but found to be perfectly working by our laboratories, will be charged a flat fee to account for checking and testing time irrespective of the warranty terms.

### SAFETY

This instrument was manufactured and tested in compliance with IEC 61010-1 CAT III - 300V class 2 standards for operating voltages up to 300 VAC rms phase to neutral.

In order to maintain this condition and to ensure safe operation, the user must comply with the indications and markings contained in the following instructions:

- When the instrument is received, before starting its installation, check that it is intact and no damage occurred during transport.
- Before mounting, ensure that the instrument operating voltages and the mains voltage are compatible then proceed with the installation.
- The instrument power supply needs no earth connection.
- The instrument is not equipped with a power supply fuse; a suitable external protection fuse must be foreseen by the contractor.
- Maintenance and/or repair must be carried out only by qualified, authorized personnel
- If there is ever the suspicion that safe operation is no longer possible, the instrument must be taken out of service and precautions taken against its accidental use.
- Operation is no longer safe when:

- 1) There is clearly visible damaged.
- 2) The instrument no longer functions.
- 3) After lengthy storage in unfavorable conditions.
- 4) After serious damage occurred during transport

The instruments must be installed in respect of all the local regulations.

### OPERATOR SAFETY

**Warning:** Failure to observe the following instructions may lead to a serious danger of death.

- During normal operation dangerous voltages can occur on instrument terminals and on voltage and current transformers. Energized voltage and current transformers may generate lethal voltages. Follow carefully the standard safety precautions while carrying out any installation or service operation.
- The terminals of the instrument must not be accessible by the user after the installation. The user should only be allowed to access the instrument front panel where the display is located.
- Do not use the digital outputs for protection functions nor for power limitation functions. The instrument is suitable only for secondary protection functions.
- The instrument must be protected by a breaking device capable of interrupting both the power supply and the measurement terminals. It must be easily reachable by the operator and well identified as instrument cut-off device.
- The instrument and its connections must be carefully protected against short-circuit.

**Precautions:** Failure to respect the following instructions may irreversibly damage to the instrument.

- The outputs and the options operate at low voltage level; they cannot be powered by any unspecified external voltage.
- The application of currents not compatible with the current inputs levels will damage to the instrument.

Further documentation may be downloaded from our web site [www.electrex.it](http://www.electrex.it).

This document is owned by company AKSE that reserves all rights.

### DECLARATION OF CONFORMITY

Akse hereby declares that its range of products complies with the following directives EMC 89/336/EEC 73/23CE 93/68 CE and complies with the following product's standard CEI EN 61326 – IEC 61326 CEI EN 61010 – IEC 61010.

The product has been tested in the typical wiring configuration and with peripherals conforming to the EMC directive and the LV directive.

## READINGS

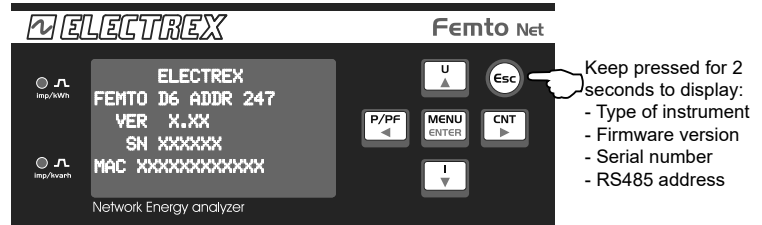

### MEASURE LIST TABLE

(The parameters available vary according to instrument configuration)

Short keypress						
Long keypress	P	P Avg Imp	P Avg Exp	P MD Imp	P MD Exp	
	Q	Q Avg Imp	Q Avg Exp	Q MD Imp	Q MD Exp	
	S	S Avg Imp	S Avg Exp	S MD Imp	S MD Exp	
	PF					
Short keypress						
Long keypress	U L-N / f	U THD L-N	U L-N Min	U L-N Max		
	U L-L / f	U THD L-L	U L-L Min	U L-L Max		
Short keypress						
	In	I	I THD	I Max	I AVG	I MD
Short keypress						
Long keypress	Ea Imp $\Sigma$	Ea Imp P	Ea Exp $\Sigma$	Ea Exp P	Ea Imp $\Sigma$ Fase	
	Er Ind Imp $\Sigma$	Er Ind Imp P	Er Ind Exp $\Sigma$	Er Ind Exp P	Er Ind Imp $\Sigma$ Fase	
	Er Cap Imp $\Sigma$	Er Cap Imp P	Er Cap Exp $\Sigma$	Er Cap Exp P		
	Es Imp $\Sigma$	Es Imp P	Es Exp $\Sigma$	Es Exp P		
	C1 Pulse $\Sigma$	C1 Pulse P				

### LEGEND OF PARAMETERS AND SYMBOLS

L-N	Phase Neutral	U	Voltage
L-L	Phase Phase	I	Current
THD	Total Harmonic Distortion	In	Neutral current
Avg	Average (rolling) value	P	Active Power
MD	Maximum Demand	Q	Reactive Power
Imp	Import value	S	Apparent Power
Exp	Export value	PF	Power Factor
Ind	Inductive	Ea	Active Energy
Cap	Capacitive	Er	Reactive Energy
Min	Minimum values (10 cycles time base)	Es	Apparent Energy
Max	Maximum values (10 cycles time base)	f	Frequency
CNT $\Sigma$	Pulse count (total)		
CNT P	Pulse count (partial)		

### MECHANICAL CHARACTERISTICS

Case	Self-extinguishing plastic material class V0
Protection degree	IP40 on front panel, IP20 terminals side
Size	105 x 90 x 58 mm (6 DIN modules)

### VOLTAGE INPUT

Direct insertion	Up to 300 Vrms phase-neutral or 520 Vrms phase to phase
With external VT:	Primary: programmable (max. 400 kV) Secondary: programmable (max. 300 V)
	Overload: 900 Vrms phase to phase for 1 sec
Aux. power supply	85/265Vac +/- 10% 50/60Hz
Self consumption:	< 2 watt

### MODELS

PFN66-EQ5Q9-A21, PFN66-E15Q9-110, PFN66-E15Q9-F11, PFN66-E15Q9-F10

## DESCRIPTION OF KEYS

	Short keypress	Long keypress
	Confirm parameter	Enter/Exit from the device's configuration menu
	Modify parameter	
	Modify parameter	
	Go to previous value	Go to previous page
	Go to next value	Go to next page
	Exit without saving the configuration	

## MEASURES

On "MEAS" page are displayed the main measures of the device (voltage, current, power, energy, etc.).

ELECTREX	SET
FEMTO D6 ADDR 247	RESET
VER X.XX	MEAS
SN XXXXXX	HARM
MAC XXXXXXXXXXXXX	PAGE

## HARMONICS

On "HARM" page are displayed the harmonics (from 2<sup>nd</sup> to the 32<sup>nd</sup>) for voltage and current.

ELECTREX	RESET	
FEMTO D6 ADDR 247	MEAS	
VER X.XX	HARM	
SN XXXXXX	PAGE	
MAC XXXXXXXXXXXXX	STAT	

	Select measure (U1N, U2N, U3N, I1, I2, I3)
	Select harmonic (from H2 to H32 - value in %)
	Exit without saving the configuration

## PAGE

ELECTREX	MEAS
FEMTO D6 ADDR 247	HARM
VER X.XX	PAGE
SN XXXXXX	STAT
MAC XXXXXXXXXXXXX	SET

In development

## STAT

The "STAT" page shows the assigned IP address of the LAN and WI-FI port (if present)

ELECTREX	HARM	ETH
FEMTO D6 ADDR 247	PAGE	ETH 192.168.027.001
VER X.XX	STAT	WIFI 192.168.026.001
SN XXXXXX	SET	
MAC XXXXXXXXXXXXX	RESET	

## RESET

The "RESET" page allows to reset the total (TOT) and partial (PAR) energy counters, the minimum and maximum values (MAX) and the historical maximum values (MD).

ELECTREX		
FEMTO D6 ADDR 247	STAT	
VER X.XX	SET	
SN XXXXXX	RESET	
MAC XXXXXXXXXXXXX	MEAS	
	HARM	
PASSWORD REQUEST	0000 ... 9999	0000
COUNTERS		
TOT	N, Y	
PAR	N, Y	
MAX	N, Y	
MD	N, Y	
COUNTERS		
TOT	N	
PAR	N	
MAX	N	
MD	N	
CHANGE PWD		
PWD	0000...9999	0000

## DEVICE SETUP

ELECTREX	PAGE
FEMTO D6 ADDR 247	STAT
VER X.XX	SET
SN XXXXXX	RESET
MAC XXXXXXXXXXXXX	MEAS

## SETUP SEQUENCE

PAGE	PARAMETERS	VALUES AVAILABLE	DEFAULT
PASSWORD REQUEST		0000 ... 9999	0000
NET Note n.4			
	DEF	ETH, WIFI	ETH
	ETH	N, Y	Y
	WIFI	N, Y	Y
NET			
DEF ETH			
ETH Y			
WIFI Y			
ETH Note n.5			
	DHCP	N, Y	N
	IP	xxx.xxx.xxx.xxx	192.168.027.001
	NETM	xxx.xxx.xxx.xxx	255.255.255.000
	GWAY	xxx.xxx.xxx.xxx	127.000.000.001
ETH			
DHCP N			
IP 192.168.027.001			
NETM 255.255.255.000			
GWAY 127.000.000.001			
WIFI Note n.5			
	DHCP	N, Y	N
	IP	xxx.xxx.xxx.xxx	192.168.026.001
	NETM	xxx.xxx.xxx.xxx	255.255.255.000
	GWAY	xxx.xxx.xxx.xxx	127.000.000.001
WIFI			
DHCP N			
IP 192.168.026.001			
NETM 255.255.255.000			
GWAY 127.000.000.001			
LCD Note n.3			
	DIM	DISABLE, ENABLE	DISABLE
	TIME	1...90 (sec)	3
	LIGHT	300...1000	500
	PULSE	DISABLE, ENABLE	ENABLE
LCD			
DIM DISABLE			
TIME 3			
LIGHT 0500			
PULSE ENABLE			
CHANGE PWD			
	PWD	0000...9999	0000
MEAS-A Note n.1			
	NET	3PH-4W, 2PH-2W, 1PH-2W, 3PH-3W-2C	3P-4W
	IMP / EXP		EXP
	CT	100,32,16 / 100,32,16	100/100
	VT	1...400000 / 1...300	1/1
MEAS-A			
NET 3P-4W / EXP			
CT 00005 / 5			
VT 000001 / 001			
MEAS-B Note n.2			
	I AVG	1...60 (MINUTES)	8
	P AVG	1...60 (MINUTES)	15
MEAS-B			
I AVG 8			
P AVG 15			
RS485-A			
	MODE	SLAVE, MASTER	SLAVE
	TOUT	100...10000 (ms)	3000
	RETR	0...9	3
RS485-A			
MODE SLAVE			
TOUT 03000			
RETR 3			
RS485-B			
	ADDR	1 ... 247	27
	Swap	None, B = byte, W = word, D = doubleword	NONE
	COM1	2400, 4800, 9600, 19200, 38400	38400
	Data Bit	5...8	8
	Parity	N = none, E = even, O = odd	N
	Stop Bit	1 or 2	2
	ST (Silent Time)	0...5000 (ms)	150
RS485-B			
ADDR 247			
COM1 38400 / 8			
COM2 N / 2			
ST 0150			

NOTE n.1		
NET	3PH-3W-2CT	2 phases 3 wires, triangle
	3PH-4W	3 phases 4 wires, Star
	2PH-2W	2 phases 2 wires, biphas
	1PH-2W	1 phase 2 wires, monophas
CT	Primary / Secondary of the current transformer (CT)	
VT	Primary / Secondary of the voltage transformer (VT)	
NOTE n.2		
P AVG	Integration time of the average value (AVG) and peak value (MD) for power (from 1 to 60 minutes)	
I AVG	Integration time of the average value (AVG) and peak value (MD) for current (from 1 to 60 minutes)	
NOTE n.3		
DIM	Enable / Disable dimming of the display	
TIME	Time in seconds after which the display luminosity is reduced. (With DIM enabled)	
LIGHT	Luminosity level of the display	
PULSE	Enable / Disable the flashing of the sine wave symbol  light near the Electrex logo.	
NOTE n.4		
DEF	Selects the default network interface to be used for the communication	
ETH	Enable / Disable the Ethernet (LAN) port	
WIFI	Enable / Disable the WIFI port	
NOTE n.5		
DHCP	Enable / Disable the search for a DHCP server in the network	
IP	IP address of the network interface	
NETM	Subnet mask: defines the belonging range of a host within an IP subnetwork	
GWAY	IP address of the gateway	

## INPUT & OUTPUT CONNECTION

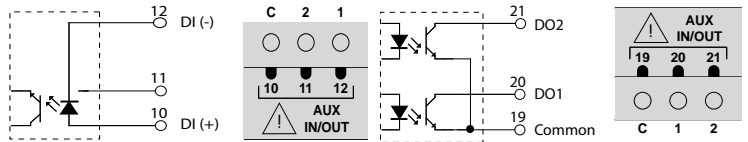



Digital Inputs	
Supply voltage (external):	from 10 to 30 Vdc
Current consumption:	from 2 to 10mA
Max. count frequency	10 or 100Hz
N.B. For gas meters a galvanic separation is needed per ATEX standards	

Digital outputs (optocoupled NPN transistor type for DIN 43864)	
Maximum applicable voltage:	27 Vdc
Maximum switchable current:	27 mA

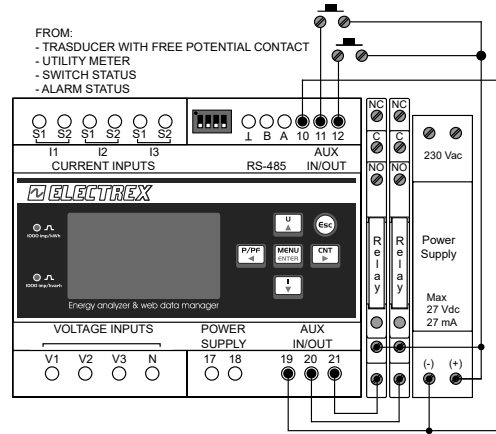
## INPUT & OUTPUT CONNECTION EXAMPLE



## DIP-SWITCH CONFIGURATION

DIP	FUNCTION	SLAVE	MASTER *
1	Line termination resistance (120 Ohm)	OFF	ON
2	Fail safe resistance B (-)	OFF	ON
3	Fail safe resistance A (+)	OFF	ON
4	Not used	OFF	OFF
* with RS-485 Master PUK activated			

## LAN 10/100 ETHERNET PORT

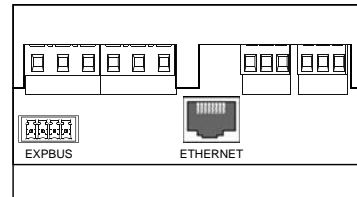

The instrument is equipped with a Ethernet Lan 10/100 Auto-MDI/MDIX port. For the connection can be used a data cable straight or crossover.

Note: the port is not a PoE (Power over Ethernet = device power supply via the Lan port) type. The connection of the device to a PoE port is anyway accepted. The power supply anyway must be always provided by an external power supplier.

## EXPBUS PORT

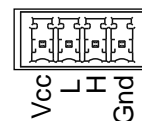

The ExpBus port, configurable via Ethernet port on web pages:

- uses a multicast communication rated at 250kb/sec with collision management
- max cable length : 10 meters
- manages up to 16 modules (but technically can manage up to 126)
- uses the UTP cable, 4 wires used:

- 2 for the power supply at 9 Vdc
- 2 for the bidirectional communication

The modules will also power supply the ExpBus port

The cable must be connected in in-out modality (multidrop) as per the RS485 Bus.

## MESSAGE "CFG ERROR"

During the set up operation a "CFG ERROR" message could appear. This means that some wrong parameters are inserted.

CFG ERROR

## VOLTAGE AND CURRENT CONNECTION

**Voltage connection:** Use cables with max cross-section of 2,5 mm<sup>2</sup> if stranded 4 mm<sup>2</sup> if rigid and connect them to the clamps marked VOLTAGE INPUT on the instrument according to the applicable diagrams that follow.

**Current connection:** Use exclusively the CT provided together with the instrument. Connect the CT output(s) to the terminals marked I1, I2, I3 (CURRENT INPUT) of the instrument according to the applicable diagrams that follow.

**N.B.** The CT secondary must always be in short circuit when not connected to the instrument in order to avoid damages and risks for the operator.

Scrupulously respect the matching of phase between the voltage signals and current signals (RTD) and the direction of insertion of CT (P1-P2 and S1-S2). Failure to comply with this correspondence and connection diagrams gives rise to measurement errors. Do NOT extend in any modality the length of the CT wires.

### STAR 4W (4 WIRES) 3PH-4W LV

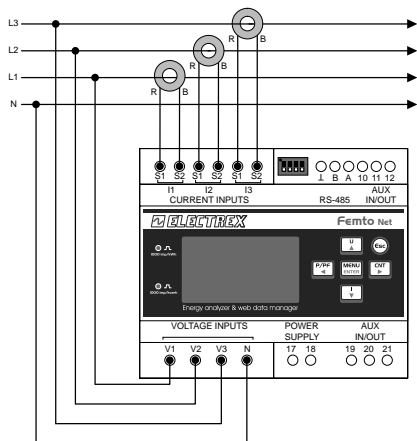

### STAR 4W (4 WIRES) 3PH-4W MV

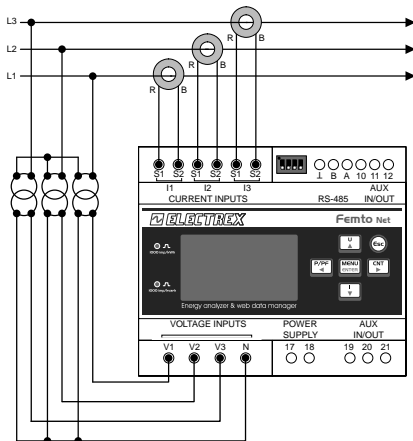

### MONOFASE (2 WIRES) 1PH-2W

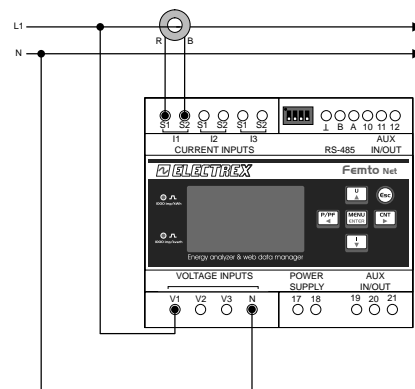

### TRIANGLE 3W (3 WIRES) 3PH-3W

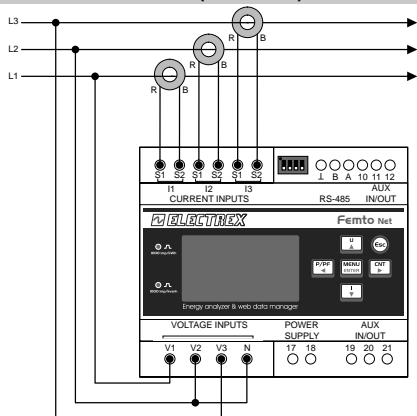

### BI-PHASE (2 WIRES) 2PH-2W

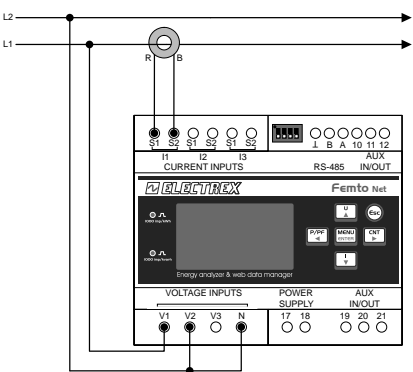

### TRIANGLE 2CT (3 WIRES) 3PH-3W

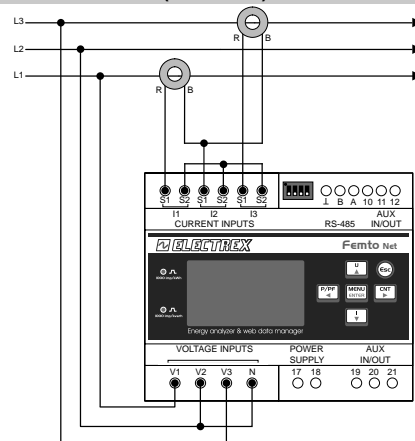

### TRIANGLE 2CT(3 WIRES) 3PH-3W MV

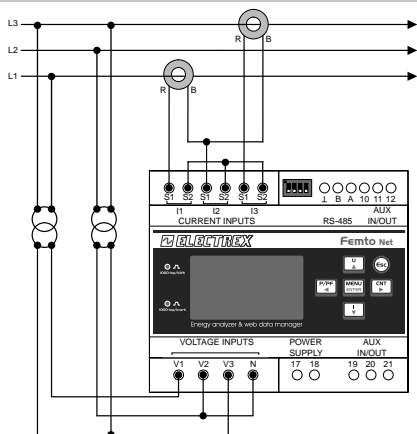

### POWER SUPPLY

The instrument is fitted with a separate power supply. The power supply terminals are numbered (17 e 18). Use cables with max cross-section of 2,5 mm<sup>2</sup> if stranded, 4 mm<sup>2</sup> if rigid.

