

### COPYRIGHT

Electrex is a trademark of Akse S.r.l. All rights reserved.  
It is forbidden to duplicate, adapt, transcript this document without Akse written authorization, except when regulated accordingly by the Copyright Laws.

### WARRANTY

This product is covered by a warranty against material and manufacturing defects for a 24 months period from the manufacturing date.

The warranty does not cover the defects that are due to:

- Negligent and improper use
- Failures caused by atmospheric hazards
- Acts of vandalism
- Wear out of materials
- Firmware upgrades

Akse reserves the right, at its discretion, to repair or substitute the faulty products

The warranty is not applicable to the products that will result defective in consequence of a negligent and improper use or an operating procedure not contemplated in this manual.

### RETURN AND REPAIR FORMALITIES

Akse accepts the return of instruments for repair only when authorized in advance. The transport costs are at customer charge.

### RE-SHIPING OF REPAIRED PRODUCT

The terms for re-shipment of repaired products are ex-works, i.e. the transport costs are at customer charge.

Products returned as defective but found to be perfectly working by our laboratories, will be charged a flat fee to account for checking and testing time irrespective of the warranty terms.

### SAFETY

This instrument was manufactured and tested in compliance with IEC 61010-1 CAT III - 300V class 2 standards for operating voltages up to 300 VAC rms phase to neutral.

In order to maintain this condition and to ensure safe operation, the user must comply with the indications and markings contained in the following instructions:

- When the instrument is received, before starting its installation, check that it is intact and no damage occurred during transport.
- Before mounting, ensure that the instrument operating voltages and the mains voltage are compatible then proceed with the installation.
- The instrument power supply needs no earth connection.
- The instrument is not equipped with a power supply fuse; a suitable external protection fuse must be foreseen by the contractor.
- Maintenance and/or repair must be carried out only by qualified, authorized personnel
- If there is ever the suspicion that safe operation is no longer possible, the instrument must be taken out of service and precautions taken against its accidental use.

Operation is no longer safe when:

- There is clearly visible damaged.
- The instrument no longer functions.
- After lengthy storage in unfavorable conditions.
- After serious damage occurred during transport

The instruments must be installed in respect of all the local regulations.

### OPERATOR SAFETY

**Warning:** Failure to observe the following instructions may lead to a serious danger of death.

- During normal operation dangerous voltages can occur on instrument terminals and on voltage and current transformers. Energized voltage and current transformers may generate lethal voltages. Follow carefully the standard safety precautions while carrying out any installation or service operation.
- The terminals of the instrument must not be accessible by the user after the installation. The user should only be allowed to access the instrument front panel where the display is located.
- Do not use the digital outputs for protection functions nor for power limitation functions. The instrument is suitable only for secondary protection functions.
- The instrument must be protected by a breaking device capable of interrupting both the power supply and the measurement terminals. It must be easily reachable by the operator and well identified as instrument cut-off device.
- The instrument and its connections must be carefully protected against short-circuit.

**Precautions:** Failure to respect the following instructions may irreversibly damage to the instrument.

- The outputs and the options operate at low voltage level; they cannot be powered by any unspecified external voltage.
- The application of currents not compatible with the current inputs levels will damage to the instrument.

Further documentation may be downloaded from our web site [www.electrex.it](http://www.electrex.it).

This document is owned by company AKSE that reserves all rights.

### DECLARATION OF CONFORMITY

Akse hereby declares that its range of products complies with the following directives EMC 2014/30/EU, 2014/35/EU and complies with the following product's standard CEI EN 61326 - Ed. 2.0 (2012) - IEC 61326 - Ed. 2.0 (2012) CEI EN 61010 Ed. 3 (2010) - IEC 61010 Ed. 3 (2010). The product has been tested in the typical wiring configuration and with peripherals conforming to the EMC directive and the LV directive.

## READINGS



### MEASURE LIST TABLE

(The parameters available vary according to instrument configuration)

Short keypress						
Long keypress	P	P Avg Imp	P Avg Exp	P MD Imp	P MD Exp	
	Q	Q Avg Imp	Q Avg Exp	Q MD Imp	Q MD Exp	
	S	S Avg Imp	S Avg Exp	S MD Imp	S MD Exp	
	PF					
Short keypress						
Long keypress	U L-N / f	U THD L-N	U L-N Min	U L-N Max		
	U L-L / f	U THD L-L	U L-L Min	U L-L Max		
Short keypress						
	In	I	I THD	I Max	I AVG	I MD
Short keypress						
Long keypress	Ea Imp $\Sigma$	Ea Imp P	Ea Exp $\Sigma$	Ea Exp P	Ea Imp $\Sigma$ Fase	
	Er Ind Imp $\Sigma$	Er Ind Imp P	Er Ind Exp $\Sigma$	Er Ind Exp P	Er Ind Imp $\Sigma$ Fase	
	Er Cap Imp $\Sigma$	Er Cap Imp P	Er Cap Exp $\Sigma$	Er Cap Exp P		
	Es Imp $\Sigma$	Es Imp P	Es Exp $\Sigma$	Es Exp P		
	C1 Pulse $\Sigma$	C1 Pulse P				

### LEGEND OF PARAMETERS AND SYMBOLS

L-N	Phase Neutral	U	Voltage
L-L	Phase Phase	I	Current
THD	Total Harmonic Distortion	In	Neutral current
Avg	Average (rolling) value	P	Active Power
MD	Maximum Demand	Q	Reactive Power
Imp	Import value	S	Apparent Power
Exp	Export value	PF	Power Factor
Ind	Inductive	Ea	Active Energy
Cap	Capacitive	Er	Reactive Energy
Min	Minimum values (10 cycles time base)	Es	Apparent Energy
Max	Maximum values (10 cycles time base)	f	Frequency
CNT $\Sigma$	Pulse count (total)		
CNT P	Pulse count (partial)		

### MECHANICAL CHARACTERISTICS

Case	Self-extinguishing plastic material class V0
Protection degree	IP40 on front panel, IP20 terminals side
Size	150 x 45 x 100 mm

### VOLTAGE INPUT

Direct insertion	Up to 300 Vrms phase-neutral or 519 Vrms phase to phase
With external VT:	Primary: programmable (max. 400 kV) Secondary: programmable (max. 300 V)
	Overload: 900 Vrms phase to phase for 1 sec
Aux. power supply	85+265Vac +/- 10% 50/60Hz
Self consumption:	< 2,5VA

### MODELS

PFALT-EH5D90-110

## DEVICE SETUP

### DESCRIPTION OF KEYS

	Short keypress	Long keypress		Short keypress	Long keypress
	Confirm parameter	Setup confirmation		Go to previous value	Go to previous page
	Modify parameter			Go to next value	Go to next page
	Modify parameter			Exit without saving the configuration	

ENTER THE SETUP		EXIT THE SETUP	
Push for 2 seconds		Push for 2 seconds	
Using the keys  or  select SET from the menu			
Push the key			

### SETUP SEQUENCE

PAGE	PARAMETERS	VALUES AVAILABLE	DEFAULT
<b>PASSWORD</b>			
	PASSWORD	0000 ... 9999	0000
<b>MEAS-A Note n.1</b>			
<b>MEAS-A</b>	NET	3PH-4W, 2PH-2W, 1PH-2W, 3PH-3W-2C	3PH-4W
NET 3P-4W / EXP	EXPORT	IMP / EXP	EXP
CT 00100 / 100	CT	100,32,16 / 100,32,16	100/100
VT 000001 / 001	VT	400000/300	1/1
<b>MEAS-B Note n.2</b>			
<b>MEAS-B</b>	I AVG 8	1...60 (minutes)	8
P AVG 15	P AVG	1...60 (minutes)	15
<b>RS485-A Note n.3</b>			
<b>RS485-A</b>	MODE	SLAVE, MASTER	SLAVE
MODE SLAVE	TOUT	100...10000 (ms)	3000
TOUT 03000	RETR	0...9	3
RETR 3			
<b>RS485-B</b>			
<b>RS485-B</b>	ADDR (485 address)	1 ... 247	247
ADDR 247	COM1 (Baud rate)	2400, 4800, 9600, 19200, 38400	38400
COM1 38400 / 8	COM1 (Data Bit)	7 or 8	8
COM2 N / 2	COM2 (Parity)	N = no parity, E = even parity, O = odd parity	N
ST 0150	COM (Stop bit)	1 or 2	2
	S.T. (Silent Time)	0 ... 1000 mS (Step of 10)	100
<b>ETH Note n.4</b>			
<b>ETH</b>	DHCP	N, Y	N
DHCP N	IP	xxx.xxx.xxx.xxx	192.168.027.001
IP 192.168.027.001	NETM	xxx.xxx.xxx.xxx	255.255.255.000
NETM 255.255.255.000	GWAY	xxx.xxx.xxx.xxx	127.000.000.001
GWAY 127.000.000.001			
<b>WIFI Note n.4</b>			
<b>WIFI</b>	DHCP	N, Y	N
DHCP N	IP	xxx.xxx.xxx.xxx	192.168.026.001
IP 192.168.026.001	NETM	xxx.xxx.xxx.xxx	255.255.255.000
NETM 255.255.255.000	GWAY	xxx.xxx.xxx.xxx	127.000.000.001
GWAY 127.000.000.001			
<b>NET Note n.5</b>			
<b>NET</b>	DEF	ETH, WIFI	ETH
DEF ETH	ETH	N, Y	Y
ETH Y	WIFI	N, Y	Y
WIFI Y			
<b>LCD Note n.6</b>			
<b>LCD</b>	DIM	DISABLE, ENABLE	DISABLE
DIM DISABLE	TIME	1...90 (sec)	3
TIME 3	LIGHT	300...1000	500
LIGHT 0500	PULSE	DISABLE, ENABLE	ENABLE
PULSE ENABLE			
<b>ALARM 1 / A Note n.7</b>			
<b>ALARM 1-A</b>	MODE	NORMAL, 1-OF-3, 3-OF-3, UNBAL%, DERIV, UNBAL	NORMAL
MODE NORMAL	TYPE	MIN, MAX	MAX
TYPE MAX	MEAS (note n.5)	Controlled measure. See table n.1 for register selection	000
MEAS 000	THRE (note n.5)	Threshold value	+000.000
THRE +000.000			
<b>ALARM 1 / B Note n.8</b>			
<b>ALARM 1-B</b>	HYST	0...99 (%)	05
HYST 05	DEL	0...99 / S / M / 0...99 / S / M	01 / S / 01 / S
DEL 01 / S / 01 / S	AVG	0...99 (sec)	05
AVG 05	OUT	NORMAL, PULSE-S, PULSE-L, HOLD	NORMAL
OUT NORMAL			
<b>ALARM 2 / A (see ALARM 1/A)</b>			
<b>ALARM 2 / B (see ALARM 1/B)</b>			
<b>ALARM 3 / A (see ALARM 1/A)</b>			
<b>ALARM 3 / B (see ALARM 1/B)</b>			
<b>ALARM 4 / A (see ALARM 1/A)</b>			
<b>ALARM 4 / B (see ALARM 1/B)</b>			
<b>CHANGE PWD</b>			
	PWD	0000...9999	0000

<b>ALARM 3 / B (see ALARM 1/B)</b>			
<b>ALARM 4 / A (see ALARM 1/A)</b>			
<b>ALARM 4 / B (see ALARM 1/B)</b>			
<b>CHANGE PWD</b>			
	PWD	0000...9999	0000

### RESET

The "RESET" page allows to reset the total (TOT) and partial (PAR) energy counters, the minimum and maximum values (MAX) and the historical maximum values (MD).



### STAT

The "STAT" page shows the assigned IP address of the LAN and WI-FI port (if



**TABLE n.1 - Part of ModBus Registers; for e.g. alarm configuration. (Contact us for the full list).**

REGISTER	DESCRIPTION	SYMBOL	UNIT
218	Frequency of U1N	f	[Hz]
220	Phase to Neutral Voltage, RMS Amplitude	U1N	[V]
222	Phase to Neutral Voltage, RMS Amplitude	U2N	[V]
224	Phase to Neutral Voltage, RMS Amplitude	U3N	[V]
226	Phase to Phase Voltage, RMS Amplitude	U12	[V]
228	Phase to Phase Voltage, RMS Amplitude	U23	[V]
230	Phase to Phase Voltage, RMS Amplitude	U31	[V]
232	Phase Current, RMS Amplitude	I1	[A]
234	Phase Current, RMS Amplitude	I2	[A]
236	Phase Current, RMS Amplitude	I3	[A]
238	Neutral Current, RMS Amplitude	IN	[A]
240	Phase Active Power ( Imp/ Exp)	P1	[W]
242	Phase Active Power ( Imp/ Exp)	P2	[W]
244	Phase Active Power ( Imp/ Exp)	P3	[W]
246	Phase Reactive Power ( Imp/ Exp)	Q1	[var]
248	Phase Reactive Power ( Imp/ Exp)	Q2	[var]
250	Phase Reactive Power ( Imp/ Exp)	Q3	[var]
252	Phase Apparent Power	S1	[VA]
254	Phase Apparent Power	S2	[VA]
256	Phase Apparent Power	S3	[VA]
258	Phase Power Factor ( Imp/ Exp)	PF1	[-]
260	Phase Power Factor ( Imp/ Exp)	PF2	[-]
262	Phase Power Factor ( Imp/ Exp)	PF3	[-]
270	Phase to Neutral Voltage, Mean RMS Amplitude	UI	[V]
272	Phase to Phase Voltage, Mean RMS Amplitude	UD	[V]
274	Three phase current, RMS Amplitude	I	[A]
276	Total active power ( Imp/ Exp)	PS	[W]
278	Total reactive power ( Imp/ Exp)	QS	[var]
280	Total apparent power	SS	[VA]
282	Total power factor ( Imp/ Exp)	PFS	[-]
332	Phase Current, RMS Amplitude, AVG	I1 AVG	[A]
334	Phase Current, RMS Amplitude, AVG	I2 AVG	[A]
336	Phase Current, RMS Amplitude, AVG	I3 AVG	[A]
344	Total imported active power, AVG	P Imp AVG	[W]
346	Total imported inductive power, AVG	Qind Imp AVG	[var]
348	Total imported capacitive power, AVG	Qcap Imp AVG	[var]
350	Total imported apparent power, AVG	S Imp AVG	[VA]
352	Total exported active power, AVG	P Exp AVG	[W]
354	Total exported inductive power, AVG	Qind Exp AVG	[var]
356	Total exported capacitive power, AVG	Qcap Exp AVG	[var]
358	Total exported apparent power, AVG	S Exp AVG	[VA]

<b>NOTE n.1</b>		
NET	3PH-3W-2CT 3PH-4W 2PH-2W 1PH-2W IMP/EXP	2 phases 3 wires, Triangle 3 phases 4 wires, Star 2 phases 2 wires, Bi-phase 1 phase, 2 wires, Single phase
CT	Primary / Secondary of the current transformer (CT)	
VT	Primary / Secondary of the voltage transformer (VT)	
<b>NOTE n.2</b>		
P AVG	Integration time for Power of the average value (AVG) and peak value (MD)	
I AVG	Integration time for Current of the average value (AVG) and peak value (MD)	
<b>NOTE n.3</b>		
MODE	SLAVE MASTER	RS485 port set as Slave of the network. RS485 port set as Master of the network.
TOUT	Predetermined time in which a given operation must be terminated	
RETR	Number of communication attempts on the RS485 port	
<b>NOTE n.4</b>		
DHCP	Enable / Disable the search for a DHCP server in the network	
IP	IP address of the network interface	
NETM	Subnet mask: defines the belonging range of a host within an IP subnetwork	
GWAY	IP address of the gateway	
<b>NOTE n.5</b>		
DEF	Selects the default network interface to be used for the communication	
ETH	Enable / Disable the Ethernet (LAN) port	
WIFI	Enable / Disable the WIFI port	
<b>NOTE n.6</b>		
DIM	Enable / Disable dimming of the display	
TIME	Time in seconds after which the display luminosity is reduced. (With DIM enabled)	
LIGHT	Luminosity level of the display	
PULSE	Enable / Disable the flashing of the sine wave symbol  light near the Electrex logo.	
<b>NOTE n.7</b>		
MODE	NORMALE 1-OF-3 3-OF-3 DERIV UNBAL	Classic Alarm with reference to a fixed threshold or to maximum and minimum delay and applicable hysteresis. "AVG" parameter is not used. Considers also the 2 following registers of the selected one in "MEAS". It operates on a fixed max or min threshold with delay and applicable hysteresis. If one of the three registers exceeds the threshold the alarm goes ON. "AVG" parameter is not used. Considers also the 2 following registers of the selected one in "MEAS". It operates on a fixed max or min threshold with delay and applicable hysteresis. When all the three registers exceed the threshold the alarm goes ON. "AVG" parameter is not used. "THRE" parameter becomes a % value, "AVG" parameter is used. The instant value applied to the alarm on "MEAS" is compared with its value mediated obtained on the basis of the time set on "AVG". When the instantaneous value combined alarm differs in more (setting "Max") or less (setting "MIN") from the average value ("AVG") of the percentage set on "THRE" the alarm goes on. With delay and applicable hysteresis. Considers also the 2 following registers of the selected one in "MEAS". "THRE" parameter becomes a % value. Alarm goes on when one of the three register is different from the percentage set on "THRE" comply with the higher value of the three read register if "MAX" is set on "TYPE", or comply with the lower value of the three register if "MIN" is set on "TYPE" With delay and applicable hysteresis.
TYPE	MAX MIN	Alarm setting in excess or in decrease compared with the predefined conditions. With the exception of "UNBAL and UNBAL%".
MEAS	Indicates which register (measure) the alarm is related to. See table N.1 Input Register.	
THRE	Alarm threshold in absolute value, with the exception made for "DERIV" and "UNBAL" in which the value inserted becomes a percentage.	
<b>NOTE n.8</b>		
HYST	Hysteresis, ie the cycle between alarm value and alarm return value. It is a particularly useful function to avoid unwanted oscillations and / or alarms. Example: Alarm on current set at 100 A Max with 5% hysteresis. The alarm is activated at 100 A and is deactivated at 95 A	
DEL	Delay time (between 1 sec and 99 min) for activation. Delay time (between 1 sec and 99 min) for deactivation.	
AVG	Parameter to be used in "DERIV" mode only. Moving window width (in secs) used to create a reference value with which to compare the instantaneous data	
OUT	NORMAL HOLD PULSE-L PULSE-S	Alarm remains active during the duration of the event. It restores automatically. Alarm remains active until the manual reset via Modbus. Generates a 500ms impulse when the alarm goes on. Generates a 100ms impulse when the alarm goes on.

### ALARM SETUP EXAMPLE

To ensure that the exit "DIGITAL OUT 1" remains excited for the alarm duration (latching) when average active power (MEAS 344) exceeds the value of 100 kW, hysteresis, 5% and latency of 5 seconds set the parameters such as table:

ALARM 1 / A	MODE (note n.3)	NORMAL, UNBAL%, UNBAL, 3-OF-3, 1-OF-3	NORMAL
	TYPE (note n.4)	MAX, MIN	MAX
ALARM 1 / B	MEAS (note n.5)	Controlled measure. See table n.1 for register selection.	344
	THRE (note n.5)	Threshold value	100000
ALARM 1 / B	HYST	1...99 (%)	5
	DELAY	1...99 (seconds)	5
	AVG (note n.6)	1...99 (seconds)	1
	OUT (note n.7)	NORMAL, HOLD	NORMAL

## INPUTS - OUTPUTS

### SETUP SEQUENCE

PAGE	PARAMETERS	VALUES AVAILABLE	DEFAULT
<b>COUNT WEIGHT</b> Note A1			
COUNT WEIGHT	IN1		+00001.000
	IN2		+00001.000
<b>ABOUNCE CLOSE</b> Note A2			
ABOUNCE CLOSE	IN1	1, 5, 50 (ms)	5
	IN2	1, 5, 50 (ms)	5
<b>ABOUNCE OPEN</b> Note A2			
ABOUNCE OPEN	IN1	1, 5, 50 (ms)	5
	IN2	1, 5, 50 (ms)	5
<b>INVERT STATUS</b> Note A3			
INVERT STATUS	IN1	N, Y	N
	IN2	N, Y	N
<b>PULSE OUT</b> Note A4			
PULSE OUT	OUT1	N, Y	N
	OUT2	N, Y	N
<b>NORM CLOSE</b> Note A5			
NORM CLOSE	OUT1	N, Y	N
	OUT2	N, Y	N
<b>PULSE WIDTH</b> Note A6			
PULSE WIDTH	OUT1	50...1000 (ms)	100
	OUT2	50...1000 (ms)	100

OUTPUTS		INPUTS	
19	C1 Common 1 (negative)	10	C2 Common 2 (negative)
20	O1 Output 1 (positive)	11	I2 Input 2
21	C2 Common 2 (negative)	12	C1 Common 1 (negative)
22	O2 Output 2 (positive)	13	I1 Input 1

OUTPUTS		INPUTS	
Maximum applicable voltage:	27 Vdc	Supply voltage (external):	da 10 a 30 Vdc
Maximum switchable current:	27mA	Current consumption:	da 2 a 10mA
		Max. count frequency	10 o 100Hz

N.B. Transistor optocoupler digital outputs (NPN) according to DIN 43864. N.B. For gas meters a galvanic separation is needed per ATEX standards

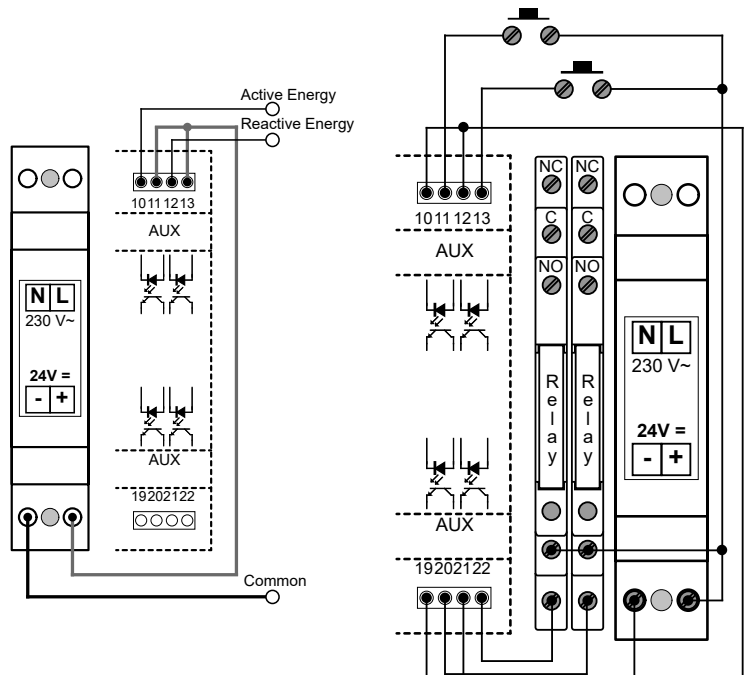

<b>NOTE A1</b>	Count Weight	Input Weight
<b>NOTE A2</b>	Abounce close	Anti-bounce setting on contact closure
	Abounce open	Anti-bounce setting on contact opening
<b>NOTE A3</b>	Invert Status	Inverts the input status
<b>NOTE A4</b>	Pulse Out	If set to "Y", set the output as an impulsive one.
<b>NOTE A5</b>	Norm Close	Set the output as normally closed.
<b>NOTE A6</b>	Pulse Width	Output pulse duration

## VOLTAGE CONNECTION

Use cables with max cross-section of 2,5 mm<sup>2</sup> if stranded, 4 mm<sup>2</sup> if rigid and connect them to the clamps marked VOLTAGE INPUT on the instrument according to the applicable diagrams that follow.

### 1P2W

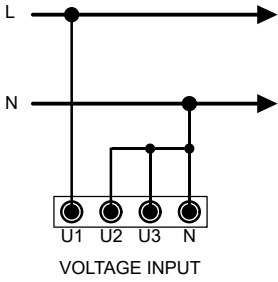

### 3I

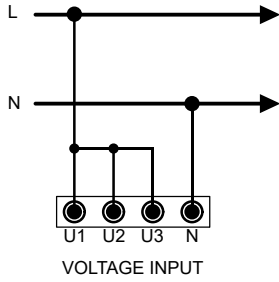

### 3P4W / 3I

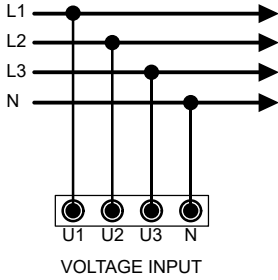

### 2P2W

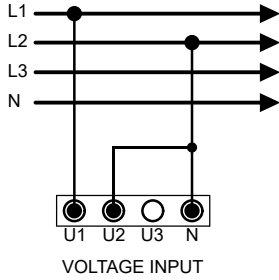

### 3P3W

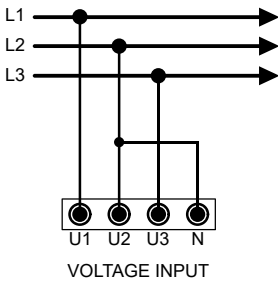

## CURRENT CONNECTION

Connect the CT outputs to the terminals marked I1, I2, I3 (CURRENT INPUT) of the instrument according to the applicable diagrams that follow.

### 1P2W / 2P2W

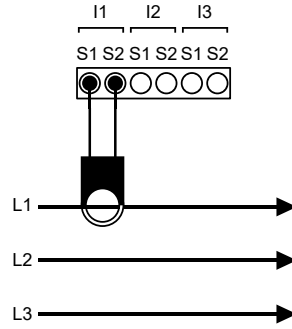

### 3P3W

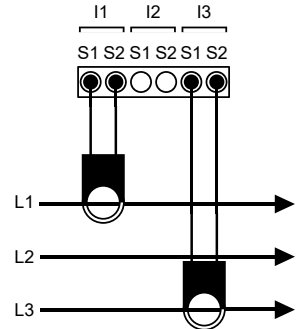

### 3P3W / 3P4W / 3I

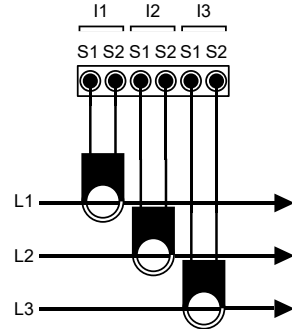

**Note:** Scrupulously respect the matching of phase between the voltage signals and current signals. Failure to comply with this correspondence and connection diagrams gives rise to measurement errors.

## DIP-SWITCH CONFIGURATION

DIP	FUNCTION	SLAVE	MASTER *
1	Line termination resistance (120 Ohm)	OFF	ON
2	Fail safe resistance B (-)	OFF	ON
3	Fail safe resistance A (+)	OFF	ON
4	Not used	OFF	OFF

\* with RS-485 Master PUK activated

## MESSAGE "CFG ERROR"

During the set up operation a "CFG ERROR" message could appear. This means that some wrong parameters are typed.

CFG ERROR

## POWER SUPPLY

The instrument is equipped with a separate power supply. The power supply terminals are numbered (17) and (18). Use cables with max cross-section of 2,5 mm<sup>2</sup> if stranded, 4 mm<sup>2</sup> if rigid.

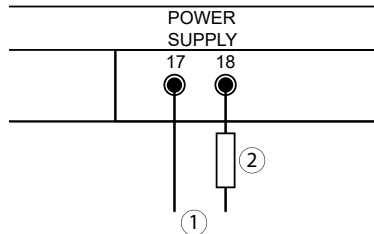

### POWER SUPPLY

1	230/240Vac +/- 10% 50/60Hz
2	F: 500 mA T

## PORTA LAN 10/100 ETHERNET



ETHERNET

The instrument is equipped with a Ethernet Lan 10/100 Auto-MDI/MDIX port. For the connection can be used a data cable straight or crossover.

Note: the port is not a PoE (Power over Ethernet = device power supply via the Lan port) type. The connection of the device to a PoE port is anyway accepted. The power supply anyway must be always provided by an external power supplier.

## EXPBUS PORT

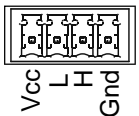

The ExpBus port, configurable via Ethernet port on web pages:

- uses a multicast communication rated at 250kb/sec with collision management
- max cable length : 10 meters
- manages up to 16 modules (but technically can manage up to 126)
- uses the UTP cable, 4 wires used:

- 2 for the power supply at 9 Vdc
- 2 for the bidirectional communication

The modules will also power supply the ExpBus port  
The cable must be connected in in-out modality (multidrop) as per the RS485 Bus.

## SERIAL LINE CONNECTION

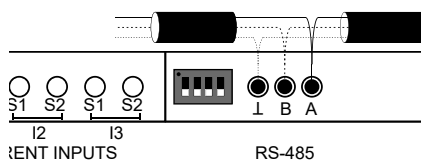

Max cable length: 1000 meters.

### RS485

Address	27
Baud rate	38400
Parity	None
Bit of Stop	2