

FEMTO D4

INSTALLATION GUIDE

COPYRIGHT

Electrex is a trademark of Akse S.r.l. All rights reserved. It is forbidden to duplicate, adapt, transcribe this document without Akse written authorization, except when regulated accordingly by the Copyright Laws.

WARRANTY

This product is covered by a warranty against material and manufacturing defects for a 24 months period from the manufacturing date.

The warranty does not cover the defects that are due to:

- Negligent and improper use
- Failures caused by atmospheric hazards
- Acts of vandalism
- Wear out of materials
- Firmware upgrades

Akse reserves the right, at its discretion, to repair or substitute the faulty products

The warranty is not applicable to the products that will result defective in consequence of a negligent and improper use or an operating procedure not contemplated in this manual.

RETURN AND REPAIR FORMALITIES

Akse accepts the return of instruments for repair only when authorized in advance. The transport costs are at customer charge.

RE-SHIPING OF REPAIRED PRODUCT

The terms for re-shipment of repaired products are ex-works, i.e. the transport costs are at customer charge.

Products returned as defective but found to be perfectly working by our laboratories, will be charged a flat fee to account for checking and testing time irrespective of the warranty terms.

SAFETY

This instrument was manufactured and tested in compliance with IEC 61010-1 CAT III - 300V class 2 standards for operating voltages up to 300 VAC rms phase to neutral.

In order to maintain this condition and to ensure safe operation, the user must comply with the indications and markings contained in the following instructions:

- When the instrument is received, before starting its installation, check that it is intact and no damage occurred during transport.
- Before mounting, ensure that the instrument operating voltages and the mains voltage are compatible then proceed with the installation.
- The instrument power supply needs no earth connection.
- The instrument is not equipped with a power supply fuse; a suitable external protection fuse must be foreseen by the contractor.
- Maintenance and/or repair must be carried out only by qualified, authorized personnel
- If there is ever the suspicion that safe operation is no longer possible, the instrument must be taken out of service and precautions taken against its accidental use.

Operation is no longer safe when:

- There is clearly visible damaged.
- The instrument no longer functions.
- After lengthy storage in unfavorable conditions.
- After serious damage occurred during transport

The instruments must be installed in respect of all the local regulations.

OPERATOR SAFETY

Warning: Failure to observe the following instructions may lead to a serious danger of death.

- During normal operation dangerous voltages can occur on instrument terminals and on voltage and current transformers. Energized voltage and current transformers may generate lethal voltages. Follow carefully the standard safety precautions while carrying out any installation or service operation.
- The terminals of the instrument must not be accessible by the user after the installation. The user should only be allowed to access the instrument front panel where the display is located.
- Do not use the digital outputs for protection functions nor for power limitation functions. The instrument is suitable only for secondary protection functions.
- The instrument must be protected by a breaking device capable of interrupting both the power supply and the measurement terminals. It must be easily reachable by the operator and well identified as instrument cut-off device.
- The instrument and its connections must be carefully protected against short-circuit.

Precautions: Failure to respect the following instructions may irreversibly damage to the instrument.

- The outputs and the options operate at low voltage level; they cannot be powered by any unspecified external voltage.
- The application of currents not compatible with the current inputs levels will damage to the instrument.

Further documentation may be downloaded from our web site www.electrex.it.

This document is owned by company AKSE that reserves all rights.

DECLARATION OF CONFORMITY

Akse hereby declares that its range of products complies with the following directives EMC 2014/30/EU, 2014/35/EU and complies with the following product's standard CEI EN 61326 - Ed. 2.0 (2012) - IEC 61326 - Ed. 2.0 (2012), CEI EN 61010 - Ed. 3 (2010) - IEC 61010 - Ed. 3 (2010). The product has been tested in the typical wiring configuration and with peripherals conforming to the EMC directive and the LV directive.

READINGS

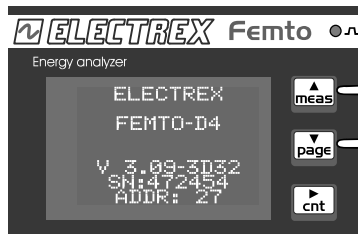

- Keep pressed for 2 seconds to display:
- Type of instrument
 - Firmware version
 - Serial number
 - RS485 address

READINGS TABLE

(The parameters available vary according to instrument configuration)

meas	→								
meas	ULN f	ULL f	I In		P	Q	S	PF	
page	ULN THD	ULL THD	I Σ		P AVG +/-	Q L AVG +/-	S AVG +/-		
Press to scroll readings	ULN MIN	ULL MIN	I THD		P MD +/-	Q C AVG +/-	S MD +/-		
	ULN MAX	ULL MAX	I MAX			Q L MD +/-			
			I AVG			Q C MD +/-			
			I MD						







→										
meas	Ea +/- MAIN	Er L +/- MAIN	Er C +/- MAIN	Es +/- MAIN	C1 MAIN	C2 MAIN	C3 MAIN	C4 MAIN	t MAIN	
page	Ea +/- P1	Er L +/- P1	Er C +/- P1	Es +/- P1	C1 P1	C2 P1	C3 P1	C4 P1	t P1	
Press to scroll readings	Ea +/- P2	Er L +/- P2	Er C +/- P2	Es +/- P2	C1 P2	C2 P2	C3 P2	C4 P2	t P2	
	Ea +/- P3	Er L +/- P3	Er C +/- P3	Es +/- P3	C1 P3	C2 P3	C3 P3	C4 P3	t P3	
	Ea + Fase	Er L + Fase	Er C + Fase	Es + Fase					t LIFE	
	Ea - Fase	Er L - Fase	Er C - Fase	Es - Fase						

LEGEND OF PARAMETERS AND SYMBOLS



U	Voltage	THD	Total Harmonic Distortion
LN	Phase Neutral	AVG	Average (rolling) value
LL	Phase Phase	MD	Maximum Demand
I	Current	MIN	Minimum values (10 cycles time base)
In	Neutral current	MAX	Maximum values (10 cycles time base)
P	Active Power	+	Import value
Q	Reactive Power	-	Export value
S	Apparent Power	Er L	Inductive
PF	Power Factor	Er C	Capacitive
f	Frequency	t	Time counting
Ea	Active Energy	C	Pulse counting
Er	Reactive Energy	MAIN	Total
Es	Apparent Energy	P1,P2,P3	Partial 1,2,3
		LIFE	Device life time

MECHANICAL CHARACTERISTICS	
Case	Self-extinguishing plastic material class V0
Protection degree	IP40 on front panel
Size	70 x 90 x 58 mm (4 DIN modules)
VOLTAGE INPUT	
Direct	Up to 300 Vrms phase-neutral or 519 Vrms phase to phase
With external PT(VT)	Primary: programmable (max. 400 kV) Secondary: programmable (max. 300 V)
	Overload: 900 Vrms phase to phase for 1 sec
Power supply	230/240Vac +/- 10% 50/60Hz
Self consumption	< 2,5VA
MODELS	
PFA6411-02-B	FEMTO D4 RS485 230-240V ENERGY ANALYZER

DEVICE SETUP

ENTER THE SETUP	EXIT THE SETUP
  	  
Push both simultaneously for 2 seconds	Push for 2 seconds

OPERATING KEYS

			
Click	Change selected field value	Change selected field value	Go to next field
Click 2 sec	Go to next window	Back to initial entry field	Exits setup

SETUP SEQUENCE

PAGE	PARAMETERS	VALUES AVAILABLE	DEFAULT
------	------------	------------------	---------

PASSWORD			
PASSWORD 0000	PASSWORD	0000 ... 9999	0000

RS-485			
RS-485	ADDR (485 address)	1 ... 247	27
	COM (Baud rate)	2400, 4800, 9600, 19200, 38400	38400
ADDR 027	COM (Data Bit)	7 or 8	8
COM 38400-8-N-2	COM (Parity)	N = no parity, E = even parity, O = odd parity	N
S.T. 100	COM (Stop bit)	1 or 2	2
	S.T. (Silent Time)	0 ... 1000 mS (Step of 10)	100

NETWORK			
NETWORK	TYPE (note n.1)	3P4W, 2P2W, 1P2W, 3I 3P3W-B-3U, 3P4W-B-3U, 3P3W-B, 3P4W-B, 3P3W	3PH-4W
TYPE 3P4W	EXPORT	NO, YES	NO
EXPORT YES	CT	10000/1 or 5	5/5
CT 00005/5	VT	400000/300	1/1
VT 000001/001			

AVG-MD TIME (note n.2)			
AVG-MD TIME	POWERS	1...60 (minutes)	15
POWER 15	CURRENTS	1...60 (minutes)	8
CURRENTS 08			

ALARM 1 / A (note n.7)			
ALARM 1/A	MODE (note n.3)	NORMAL, UNBAL%, UNBAL, 3-OF-3, 1-OF-3	NORMAL
MODE NORMAL	TYPE (note n.4)	MAX, MIN	MIN
TYPE MIN	MEAS (note n.5)	Controlled measure. See table n.1 for register selection	200
MEAS 276	THRE (note n.5)	Threshold value	0
THRE 0.000			

ALARM 1 / B			
ALARM 1/B	HYST	1...99 (%)	1
HYST 01	DELAY	1...99 (seconds)	1
DELAY 01 S/01 S	OUT (note n.6)	NORMAL, HOLD	NORMAL
OUT NORMAL			

ALARM 2 / A (see ALARM 1/A)			
ALARM 2 / B (see ALARM 1/B)			
ALARM 3 / A (see ALARM 1/A)			
ALARM 3 / B (see ALARM 1/B)			
ALARM 4 / A (see ALARM 1/A)			
ALARM 4 / B (see ALARM 1/B)			

OPTICAL TEST (note n.8)			
OPTICAL TEST	LED-1	OFF, S0-1, S0-2, S0-3, S0-4	S0-1
LED-1 S0-1			

S0-1			
S0-1	ENERGY (note n.9)	EA, ER L, ER C, ES, EA+, ER L+, ER C+, ES+, EA-, ER L-, ER C-, ES-	EA
ENERGY EA	PRIMARY (note n.10)	YES, NO	NO
PRIMARY NO	WEIGHT	0.01 ... 9.99 (K,M)	0.10
WEIGHT 1.00	WIDTH	10 ... 1000 mS	0030
WIDTH 0030			

DISPLAY			
DISPLAY	LIGHT HIGH	1 ... 3	3
LIGHT HIGH 3	LIGHT LOW	0 ... 3	1
LIGHT LOW 1	CONTRAST	0 ... 15	7
CONTRAST 7			

ENTER NEW PASSWORD			
ENTER NEW PASSWORD 0000	ENTER NEW PASSWORD	0000 ... 9999	0000

RESTORE FACTORY SETTINGS			
RESTORE FACTORY SETTINGS NO	RESTORE FACTORY SETTINGS	NO, YES	NO

CLEAR REGS/A			
CLEAR REGS/A	PHASE NRGY	NO, YES	NO
PHASE NRGY NO	MD POWER	NO, YES	NO
MD POWER NO	MD CURRENT	NO, YES	NO
MD CURRENT NO	PEAKS	NO, YES	NO
PEAKS NO			

CLEAR REGS/B			
CLEAR REGS/B	CNT MAIN	NONE, TIMER, ENERGY, ALL	NO
CNT MAIN NONE	CNT P1	NONE, TIMER, ENERGY, ALL	NO
CNT P1 NONE	CNT P2	NONE, TIMER, ENERGY, ALL	NO
CNT P2 NONE	CNT P3	NONE, TIMER, ENERGY, ALL	NO
CNT P3 NONE			

TABLE n.1 - Part of ModBus Registers for alarm configuration (Contact us for the full list).

REGISTER	DESCRIPTION	SYMBOL	UNIT
218	Frequency of U1N	f	[Hz]
220	Phase to Neutral Voltage, RMS Amplitude	U1N	[V]
222	Phase to Neutral Voltage, RMS Amplitude	U2N	[V]
224	Phase to Neutral Voltage, RMS Amplitude	U3N	[V]
226	Phase to Phase Voltage, RMS Amplitude	U12	[V]
228	Phase to Phase Voltage, RMS Amplitude	U23	[V]
230	Phase to Phase Voltage, RMS Amplitude	U31	[V]
232	Phase Current, RMS Amplitude	I1	[A]
234	Phase Current, RMS Amplitude	I2	[A]
236	Phase Current, RMS Amplitude	I3	[A]
238	Neutral Current, RMS Amplitude	IN	[A]
240	Phase Active Power (Imp/ Exp)	P1	[W]
242	Phase Active Power (Imp/ Exp)	P2	[W]
244	Phase Active Power (Imp/ Exp)	P3	[W]
246	Phase Reactive Power (Imp/ Exp)	Q1	[var]
248	Phase Reactive Power (Imp/ Exp)	Q2	[var]
250	Phase Reactive Power (Imp/ Exp)	Q3	[var]
252	Phase Apparent Power	S1	[VA]
254	Phase Apparent Power	S2	[VA]
256	Phase Apparent Power	S3	[VA]
258	Phase Power Factor (Imp/ Exp)	PF1	[-]
260	Phase Power Factor (Imp/ Exp)	PF2	[-]
262	Phase Power Factor (Imp/ Exp)	PF3	[-]
270	Phase to Neutral Voltage, Mean RMS Amplitude	UI	[V]
272	Phase to Phase Voltage, Mean RMS Amplitude	UD	[V]
274	Three phase current, RMS Amplitude	I	[A]
276	Total active power (Imp/ Exp)	PS	[W]
278	Total reactive power (Imp/ Exp)	QS	[var]
280	Total apparent power	SS	[VA]
282	Total power factor (Imp/ Exp)	PFS	[-]
332	Phase Current, RMS Amplitude, AVG	I1 AVG	[A]
334	Phase Current, RMS Amplitude, AVG	I2 AVG	[A]
336	Phase Current, RMS Amplitude, AVG	I3 AVG	[A]
344	Total imported active power, AVG	P Imp AVG	[W]
346	Total imported inductive power, AVG	Qind Imp AVG	[var]
348	Total imported capacitive power, AVG	Qcap Imp AVG	[var]
350	Total imported apparent power, AVG	S Imp AVG	[VA]
352	Total exported active power, AVG	P Exp AVG	[W]
354	Total exported inductive power, AVG	Qind Exp AVG	[var]
356	Total exported capacitive power, AVG	Qcap Exp AVG	[var]
358	Total exported apparent power, AVG	S Exp AVG	[VA]

NOTE n.1			
3P4W	3 phases	4 wires	Star
2P2W	2 phases	2 wires	Bi-phase
1P2W	1 phase	2 wires	Single phase
3I	3 phases	2 wires	Single or three phases - 3 current inputs
3P3W-B-3U	1 phases	3 wires	Balanced Triangle
3P4W-B-3U	1 phases	4 wires	Balanced Star
3P3W-B	1 phases	2 wires	Balanced Triangle
3P4W-B	1 phases	2 wires	Balanced Star
3P3W	2 phases	3 wires	Triangle
NOTE n.2			
POWERS	Integration time of the average value (AVG) and peak value (MD) for power (from 1 to 60 minutes)		
CURRENTS	Integration time of the average value (AVG) and peak value (MD) for current (from 1 to 60 minutes)		
NOTE n.3			
NORMAL	Classic Alarm with reference to a fixed threshold or to maximum and minimum delay and applicable hysteresis. "AVG" parameter is not used.		
UNBAL%	Considers also the 2 following registers of the selected one in "MEAS". "THRE" parameter becomes a % value. Alarm goes on when one of the three register is different from the percentage set on "THRE" comply with the higher value of the three read register if "MAX" is set on "TYPE", or comply with the lower value of the three register if "MIN" is set on "TYPE" With delay and applicable hysteresis.		
UNBAL	Considers also the 2 following registers of the selected one in "MEAS". "THRE" parameter becomes a % value. Alarm goes on when one of the three register is different from the percentage set on "THRE" comply with the higher value of the three read register if "MAX" is set on "TYPE", or comply with the lower value of the three register if "MIN" is set on "TYPE" With delay and applicable hysteresis.		
3-OF-3	Considers also the 2 following registers of the selected one in "MEAS". Works on a fixed max or min threshold with delay and applicable hysteresis. When all the three register exceed the threshold the alarm goes on. "AVG" parameter is not used.		
1-OF-3	Consider also the 2 following registers of the selected one in "MEAS". Works on a fixed max or min threshold with delay and applicable hysteresis. If one of the three register exceed the threshold the alarm goes on. "AVG" parameter is not used.		
NOTE n.4			
MAX	Alarm setting in excess compared with the established conditions. With the exception of "UNBAL and UNBAL%".		
MIN	Alarm setting in decrease compared with the established conditions. With the exception of "UNBAL and UNBAL%".		
NOTE n.5			
MEAS	Indicates which register (measure) the alarm is related to. See table n.1 input register.		
THRE	Alarm threshold in absolute value, with the exception made for "DERIV" and "UNBAL" in which the value inserted becomes a percentage.		
NOTE n.6			
NORMAL	Alarm remains active during the duration of the event. It restores automatically.		
HOLD	Alarm remains active until the manual reset via Modbus.		
NOTE n.7			
ALARM 1	MODBUS Alarm (Related to output 1 if present)		
ALARM 2	MODBUS Alarm (Related to output 2 if present)		
ALARM 3	MODBUS Alarm (Related to output 3 if present)		
ALARM 4	MODBUS Alarm (Related to output 4 if present)		
NOTE n.8			
LED-1	OFF	LED remains OFF	
	S0-1, 2, 3, 4	LED blinks following the pulse generator selected	
NOTE n.9			
EA	Power (Energy) Imported/Exported Active		
ER L	Power (Energy) Imported/Exported Reactive Inductive		
ER C	Power (Energy) Imported/Exported Reactive Capacitive		
ES	Power (Energy) Imported/Exported Apparent		
EA+	Power (Energy) Imported Active		
ER L+	Power (Energy) Imported Reactive Inductive		
ER C+	Power (Energy) Imported Reactive Capacitive		
ES+	Power (Energy) Imported Apparent		
EA-	Power (Energy) Exported Active		
ER L-	Power (Energy) Exported Reactive Inductive		
ER C-	Power (Energy) Exported Reactive Capacitive		
ES-	Power (Energy) Exported Apparent		
NOTE n.10			
YES	Referred to CT primary		
NO	Referred to CT secondary		

ALARM SETUP EXAMPLE

To ensure that the exit "DIGITAL OUT 1" remains excited for the alarm duration (latching) when average active power (MEAS 344) exceeds the value of 100 kW, hysteresis, 5% and latency of 5 seconds set the parameters such as table:

ALARM 1 / A	MODE (note n.3)	NORMAL, UNBAL%, UNBAL, 3-OF-3, 1-OF-3	NORMAL
	TYPE (note n.4)	MAX, MIN	MAX
	MEAS (note n.5)	Controlled measure. See table n.1 for register selection.	344
	THRE (note n.5)	Threshold value	100000
ALARM 1 / B	HYST	1..99 (%)	5
	DELAY	1..99 (seconds)	5
	AVG (note n.6)	1..99 (seconds)	1
	OUT (note n.7)	NORMAL, HOLD	NORMAL
	FUNCTION	S0-1, ALARM, REMOTE	ALARM
DIGITAL OUT 1	POLARITY	N.O., N.C.	NO
	MODE	NORMAL, PULSE,	NORMAL

VOLTAGE CONNECTION

Use cables with max cross-section of 2,5 mm² if stranded, 4 mm² if rigid and connect them to the clamps marked VOLTAGE INPUT on the instrument according to the applicable diagrams that follow.

1P2W

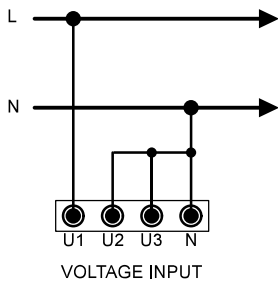

3I

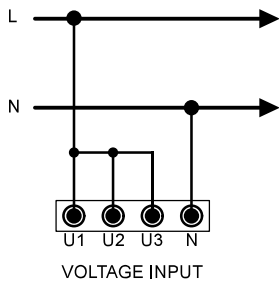

3P4W / 3P4W-B-3U / 3I

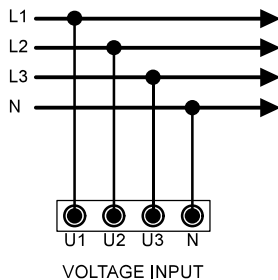

3P4W-B

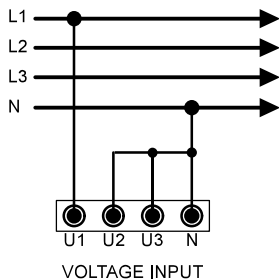

3P3W / 3P3W-B-3U

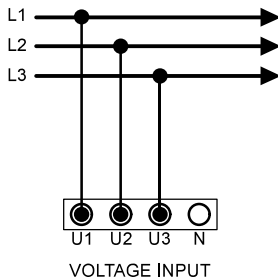

2P2W / 3P3W-B

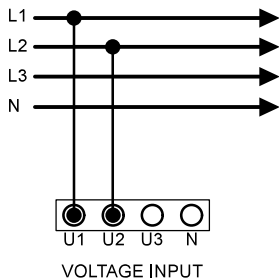

PHASE SEQUENCE

L123	Correct sequence
L132	Incorrect sequence
L---	Indicates that the device is not able to define the sequence

Please consider that:

- only the voltage sequence is detected;
- the detection considers the hypothesis that the tensions are sinusoidal (or at least slightly distorted) and belonging to a symmetrical (or almost) triad;
- independently from the insertion 3W/4W, it is considered exclusively the sign of voltage 2 and 3 in the zero-crossing of voltage for phase 1 - it is not calculated the effective phase of the voltage fundamentals;
- the phase sequence is indicated with the "L123", "L132", "L--" symbols next to frequency, in the voltages displaying page.

It is assumed:

- L1 is the voltage with phase 0°
- L2 is the voltage with phase 240° (in delay to L1)
- L3 is the voltage with phase 120° (in advance to L1)

MESSAGE "CFG ERROR"

During the set up operation a "CFG ERROR" message could appear. This means that some wrong parameters are typed. To restore the factory default settings use the following procedure (RESTORE FACTORY SETTING):

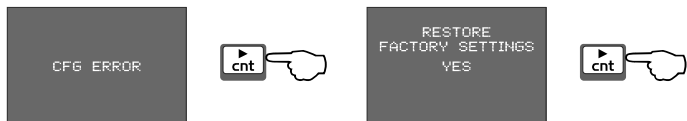

Once this procedure is done the meter is configured with its factory default settings. Logged data for counters, energy and timer will remain after the restore operation.

CURRENT CONNECTION

Connect the CT outputs to the terminals marked I1, I2, I3 (CURRENT INPUT) of the instrument according to the applicable diagrams that follow.

1P2W / 2P2W

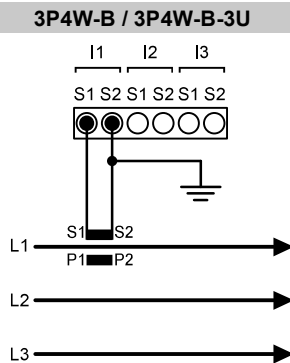

3P3W

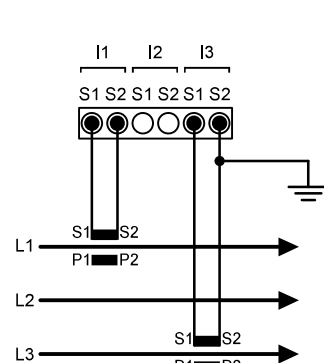

3P4W-B / 3P4W-B-3U

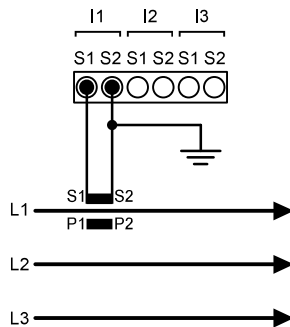

3P3W-B / 3P3W-B-3U

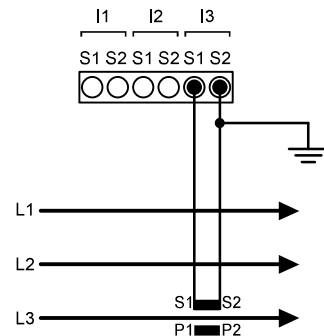
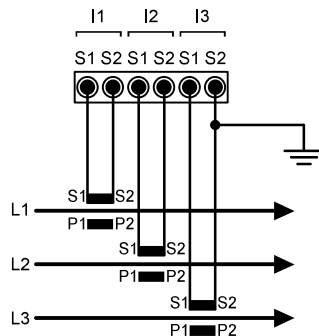

Note: Scrupulously respect the matching of phase between the voltage signals and current signals (RTD) and the direction of insertion of CT (P1-P2 and S1-S2). Failure to comply with this correspondence and connection diagrams gives rise to measurement errors.

POWER SUPPLY

The instrument is equipped with a separate power supply. The power supply terminals are numbered (17) and (18). Use cables with max cross-section of 2,5 mm² if stranded, 4 mm² if rigid.

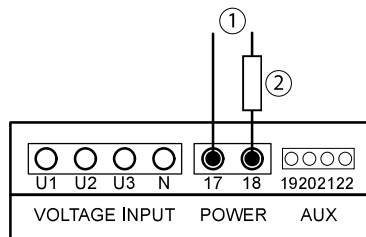

POWER SUPPLY	
1	230/240Vac +/- 10% 50/60Hz
2	F: 500 mA T

SERIAL LINE CONNECTION

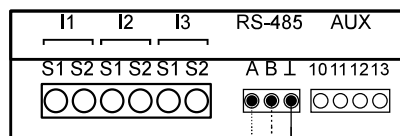

RS485	
Address	27
Baud rate	38400
Parity	None
Bit of Stop	2

Max cable length: 1000 meters.